

**GENERATOR SET**  
**SOUND-PROOF TYPE**

**OPERATION MANUAL**

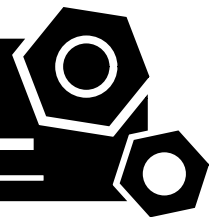

**Version Record**

Version	Date	Description
A	2013-04-18	Original release. Including PLC-920 and PLC-7420 control system
B	2014-07-20	PLC-920 control system update
C	2016-01-28	Adding the matter of auto fuel adding

# FOREWORD

Thank you for purchasing our diesel generator set.

This manual contains information for the correct operation and maintenance of your genset. It also contains important safety and installation information or troubleshooting guidelines. Please always keep this manual with the equipment for handy use.

Please operate this equipment after thoroughly reviewing and understanding the contents of this manual.

This manual does not cover diesel engine and alternator maintenance procedures. Please consult the engine and the alternator operation and maintenance manuals if necessary.

POWERLINK reserves the right to modify the characteristics of its products at any time in order to incorporate the latest technological developments. The information contained in this document may therefore be changed without notice.

Without express written permission from us, any part of this manual cannot be reproduced in any form or by any means.

Copyright 2013 POWERLINK



## SAFETY SYMBOL

This symbol, the industry's "Safety Alert Symbol", is used throughout this manual and on labels on the machine itself to warn of the possibility of personal injury. Read these instructions carefully. It is essential that you read the instructions and safety regulations before you attempt to assemble or use this unit.



### DANGER

It indicates a hazardous situation which, if not avoided, **WILL** result in serious injury or even death.



### WARNING

It indicates a hazardous situation which, if not avoided, **COULD** result in serious injury or even death.



### CAUTION

It indicates a hazardous situation which, if not avoided, **COULD** result in minor or moderate injury.



### NOTE

It indicates additional information which is important to a procedure.

# TABLE OF CONTENTS

---

## TABLE OF CONTENTS

1	Safety Information.....	1	6.8	Parameter Configuring.....	66
1.1	Safe Operation.....	1	7	Maintenance .....	67
1.2	Safety Label Location .....	4	7.1	General .....	67
1.3	Safety Label Meaning .....	14	7.2	Routine Maintenance Diagram .....	68
1.4	First Aid.....	19	7.3	Generator Set Maintenance.....	69
2	Product Overview.....	22	7.4	Air Cleaner.....	70
2.1	Applications and Features .....	22	7.5	Engine Coolant .....	70
2.2	Product Family.....	23	7.6	Engine Oil and Oil Filter.....	71
2.3	Structure .....	24	7.7	Fuel Filter.....	72
2.4	Function of Major Components.....	25	7.8	Fuel-water Separator (If applied) .....	73
2.5	Component Identification .....	26	7.9	Battery Maintenance .....	74
3	Installation.....	29	7.10	Lifting and Transporting .....	76
3.1	General Inspection Prior to Installation.....	29	7.11	Overnight Storage.....	76
3.2	Outdoor Installation Require- ments .....	29	7.12	Long-term Storage.....	76
3.3	Outdoor Installation Instructions .....	30	8	Trailer Operation & Maintenance (if applied) .....	77
3.4	Indoor Installation Requirements .....	32	8.1	General .....	77
3.5	Indoor Installation Instructions .....	34	8.2	Assembling instructions .....	78
3.6	Battery Connections .....	38	8.3	Installation Instructions .....	81
3.7	External Fuel Tank Connections (if applied).....	39	8.4	Towing Instructions .....	82
3.8	Auto Fuel Adding Connections (if applied).....	40	8.5	Trailer Maintenance .....	83
3.9	Generator Set Electricity Connections.....	41	9	Troubleshooting .....	85
4	Pre-check Before Starting.....	44	9.1	General .....	85
4.1	General Pre-check.....	44	9.2	Generator Set Troubleshooting .....	86
4.2	Checking Engine Oil Level.....	45	9.3	Control System Troubleshooting .....	87
4.3	Checking Fuel Level(Manual fuel adding system) .....	47	9.4	Engine Troubleshooting.....	88
4.4	Checking Fuel Level(Auto fuel adding system) .....	48	9.5	Alternator Troubleshooting .....	90
4.5	Checking Coolant Level.....	49	9.6	Battery Charge Troubleshooting .....	91
4.6	Checking Battery Coulomb .....	50			
5	Operation For PLC-920 Control System.....	51			
5.1	Main Electrical Components .....	51			
5.2	Control Module and Protection Function .....	52			
5.3	Operation Instruction .....	53			
5.4	Convenience Receptacles (if applied).....	55			
5.5	Terminals Diagram.....	55			
6	Operation For PLC-7420 Control System.....	56			
6.1	Main Electrical Components .....	56			
6.2	Control Module .....	57			
6.3	Working State Chart .....	58			
6.4	Operation Instruction .....	61			
6.5	Protection Function.....	64			
6.6	Convenience Receptacles (if applied).....	65			
6.7	Terminals Diagram.....	65			

# 1 Safety Information

## 1.1 Safe Operation

Before the machine leaves the factory, the parameters have been adjusted according to the practical instance. The user needn't adjust personally. Modifying or resetting the parameter of controller must be permitted and operated by the equipment administrator or manufacturer authorized person.

Before operating the machine, read the following safety regulations carefully and find out the local requirements in safety. It can reduce the possibility of personal injury, damage to the equipment, or improper service.

The operation, maintenance and repair must be carried out only by authorized and competent personnel.

The owner is responsible for maintaining the genset in good safety conditions.

Read carefully the safety symbols attached on the genset and obey all messages that follow the symbols to avoid possible injury.

### Safety Before Operation

- Do not allow any child or animal to access the operating area when the genset is working.
- All internal combustion engines create carbon monoxide gas during operation. Accumulation of this gas in an enclosure could cause illness or even death. Never operate the genset in an enclosed area without proper ventilation. Ensure the exhaust pipe and muffler are far from flammable and explosive subjects.
- Ensure the load connections and distributions are made by a qualified and experienced electrician and accord with relevant regulations, standards and other criterions of the electrical appliance.
- Ensure all insulating and grounding connections are in accord with requirements.
- Check engine oil, coolant and fuel, make sure that there is no leakage.
- Check the level of engine oil, coolant and fuel, make sure each of which is in accord with requirement.



GS-SO1

### Safety During Operation

- The operator should always wear ear protections to protect ears from being harmed due to long noise.
- Before starting the engine, make sure that all circuit breakers are set to the "OFF" position.
- Do not touch any wire when the genset is running, because they are live and may cause electrical shock.
- Do not connect or disconnect loads during running. There is high voltage whenever the engine is running. Electrical shock can cause serious or fatal injury. Loads should be connected correctly before starting.
- Do not touch the engine, radiator or exhaust gas outlet, because the temperature of their surfaces is very high and touching may cause scald.
- Do not try to move the genset when it is running.
- Do not smoke or make a fire near the genset during running. It may cause fire because the burning point of fuel is low.
- Do not press the emergency stop button at will. Only use it in an actual emergency.
- If the genset shuts down due to a fault, do not restart it until the cause has been checked out and repaired.
- Stop the genset and let it cool down completely before performing maintenance and repair.



GS-SO2

## Chemicals Safety Instructions

- Fuel and oil for the genset are flammable and may explode under certain conditions. Always treat them carefully to avoid danger in potential. Otherwise, the genset room should be equipped with BC or ABC fire extinguishers and make sure the user know how to use it.
- Only class BC or ABC fire extinguisher could be used to put out the fire.
- All the fuel and many kinds of engine oil and chemicals are flammable. Read and follow the instructions on the package.
- Ensure the engine has been cooled down before performing any operation on fuel system. It may cause fire if the fuel sprays on the hot surface or electrical components.
- All the materials should be placed in order and well protected. Flammable and metal material should be kept far away from electric power.
- Do not smoke near the gas station or engine when adding the fuel or oil.
- Battery may release hydrogen and oxygen during charging which may explode when it is hot. Keep it far away from hot area. Battery contains sulfuric acid. Never allow battery fluid to come in contact with clothing, skin or eyes. Once it happens, immediately flush the affected area with a large amount of clean water and obtain prompt medical treatment.
- Do not smoke or make a fire near the battery in any case.
- Never use the start liquid or similar things to start the engine with air pre-heat device. Otherwise, the preheater in intake manifold may explode and cause personal injury.
- Keep your hands and other body parts away from the hot surfaces such as the muffler, exhaust pipe, turbocharger (if equipped), engine block and alternator block during operation and shortly after you shut the engine down. These surfaces are extremely hot while the genset is operating and could seriously burn you.
- Follow the guideline of EPA or other governmental agencies for the proper disposal of hazardous materials such as engine oil, diesel fuel and engine coolant. Failure to follow these procedures may seriously harm the environment.
- Avoid skin contact with the high-pressure diesel fuel spray caused by fuel system leak. High-pressure fuel can penetrate your skin and result in serious injury. If you are exposed to high-pressure fuel spray, obtain prompt medical treatment.
- Wear personal protective equipment such as gloves, work shoes, goggles and hearing protection. Never wear jewelry, ties or loose-fitting clothing when you are working near moving/rotating parts such as a cooling fan, flywheel, or pulley.

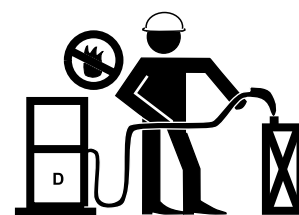

GS-S03

## Electric Safety Instructions

- Turn off the battery switch before installing and servicing the electrical system.
- Do not stand in water or on wet ground during operating and servicing the electrical system. Keep your hands and other body parts away from live parts such as cables, harness or connect terminals.
- Replace the protective cover plate of the field wiring distribution box immediately after serving and maintenance. Never operate the genset while the protective cover plate is open.
- Check and make sure the genset's characteristics are compatible with the main or standby power source system and the loads. Cut off all the power before maintenance and repair.
- Check the electrical harness for crack, abrasion, and damaged or corroded connections. Always keep the connectors and terminals clear and tight connected.
- Check and make sure all the electrical elements, harness and cables are insulated properly.



GS-S04

## Safety During Lifting and Transporting

- Always shut down the engine before lifting and transporting.
- Check the fuel and oil cap, make sure they have been tightened.
- Close all doors and lock them before lifting and transporting.
- Only use the special lifting lugs to lift the genset. It is totally forbidden to use any other lifting lugs located over the engine, alternator or other components.
- Check the lifting lugs before lifting, make sure they have been mounted correctly and welded firmly. In addition, the lifting devices should have enough capacity to lift the genset safely.
- Check the welding area of all lifting lugs. They could not be used if there is a crack.
- Do not stand nearby while lifting.
- Be careful during lifting or transporting to avoid the unnecessary damages and abrasions.
- It is totally forbidden to install or use the machine in a space storing dangerous goods.



GS-S05

## Safety During Engine Running

- Do not add or change coolant while operating the genset or immediately after stopping the machine. Otherwise it may cause serious burns.
- Do not open the radiator cap unless the coolant has been cooled down completely. First loosen the cap and release the air pressure, then open it entirely.
- Do not add fuel or oil during genset operation or shortly after shutdown, only process it when the machine is cooled down. Keep sparks, open flame or any form of ignition well away when refueling for them may cause a fire.
- Do not try to start the engine when the fan protector or other protective devices are disassembled. Never put your hand inside or near these protectors for repair or maintenance when the generator set is running.
- Keep your hands and other body parts away from the hot engine surfaces such as the muffler, exhaust pipe, turbocharger (if equipped) and engine block during operation and shortly after you shut the engine down. These surfaces are extremely hot while the engine is operating and could seriously burn you.
- Keep your hands and other body parts away from moving/rotating parts. Wear tight-fitting clothing and keep your hair short or tie it back while the engine is running.
- Never operate the engine in an enclosed area. All internal combustion engines create carbon monoxide gas during operation. Accumulation of this gas within an enclosure could cause illness or even death.

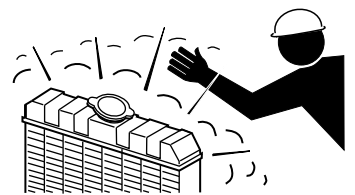

GS-S06



RS-type (4-2)

1000019425-SO2-A1

**Operating Instructions**

**Before starting:**

1. Read Operator's Manual.
2. Check level unit.
3. Check ground unit.
4. Check all fluid levels.
5. Check engine cooling fan and rap degree of tightness.
6. Check all pipes to ensure no leakage.
7. Check battery pole to ensure no calcification.

**Manual starting (for key start panel):**

1. Disconnect all external loads.
2. Turn on the power.
3. Insert the key.
4. Pre-heat the machine.
5. Turn Emergency Stop button to "ON" position.
6. Turn the key to "ON" position.

**Automatic start and remote start:**

1. Read Operator's Manual.

**Stopping:**

1. Disconnect all external loads.
2. Turn the key to "OFF" position, for automatic start or remote start machine, press the "STOP" button.
3. Fill fuel tank.

M21211

**SAFETY INSTRUCTIONS**

Improper operation of this machine can cause serious injury or even death.

Read Operator's Manual carefully before operating or servicing.

This machine should only be operated by a person with sufficient knowledge and skill to ensure safe operation.

High voltage circuits are located inside the output terminals and control panel.

- The cover and control panel should be closed before operating.
- The movable parts and hot surfaces should be isolated within the enclosure.
- All the doors should be closed and locked before operating.

M21201

**WARNING**

**ENGINE EXHAUST** can cause serious injury or even death.

- Use only proper, well ventilated areas or safe exhaust outside.

**WARNING**

**ELECTRIC SHOCK HAZARD**

- Do not touch internal wiring or connections while the machine is operating.
- Turn power off before servicing.

**WARNING**

- Before connecting this generator to any building electrical system, an isolation transformer must be installed by a licensed electrician.
- Serious injury or even death may result without transformer shield.

M21201

**diesel**

M11203

SWL      T

**WARNING**

- Always shut down engine before transporting.
- Never transport generator with air intake doors open.
- It is totally forbidden to use any other lifting points located over the engine, alternator or other components.

M21202

**WARNING**

Do not remove the pressure cap from a hot engine until the coolant temperature is below 50°C (120°F). Heated coolant spray or steam can cause severe burns.

M21203

SWL      T

RS-type (4-3)

1000019425-SO3-A1

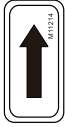

	<p><b>⚠ WARNING</b></p> <p>ENGINE EXHAUST can cause serious injury or even death.</p> <ul style="list-style-type: none"> <li>● Use only in open, well ventilated areas or vent exhaust outside.</li> </ul>
	<p>HOT SURFACES can burn skin.</p> <ul style="list-style-type: none"> <li>● DO not touch the machine until it is cooled sufficiently.</li> </ul>

M21210

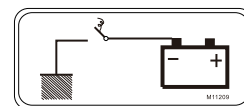
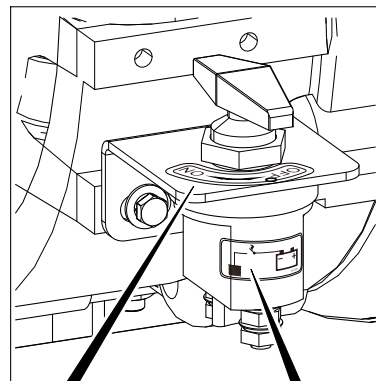
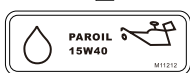
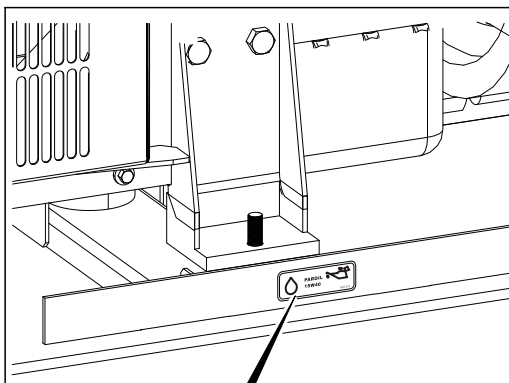
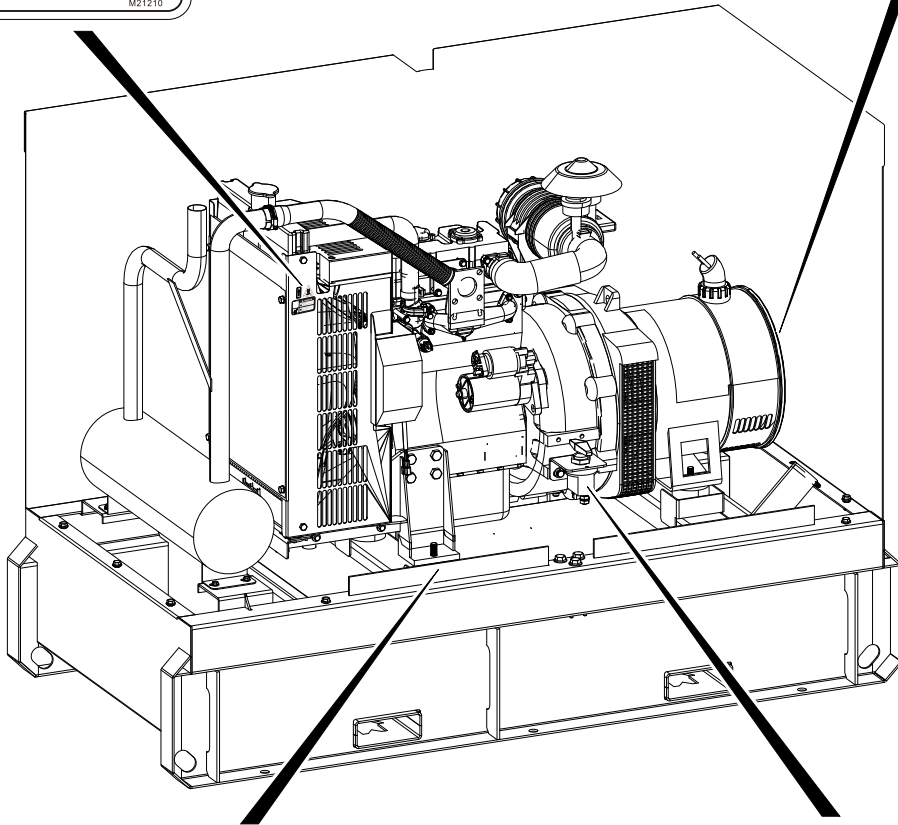

RS-type (4-4)

1000019425-SO4-A1

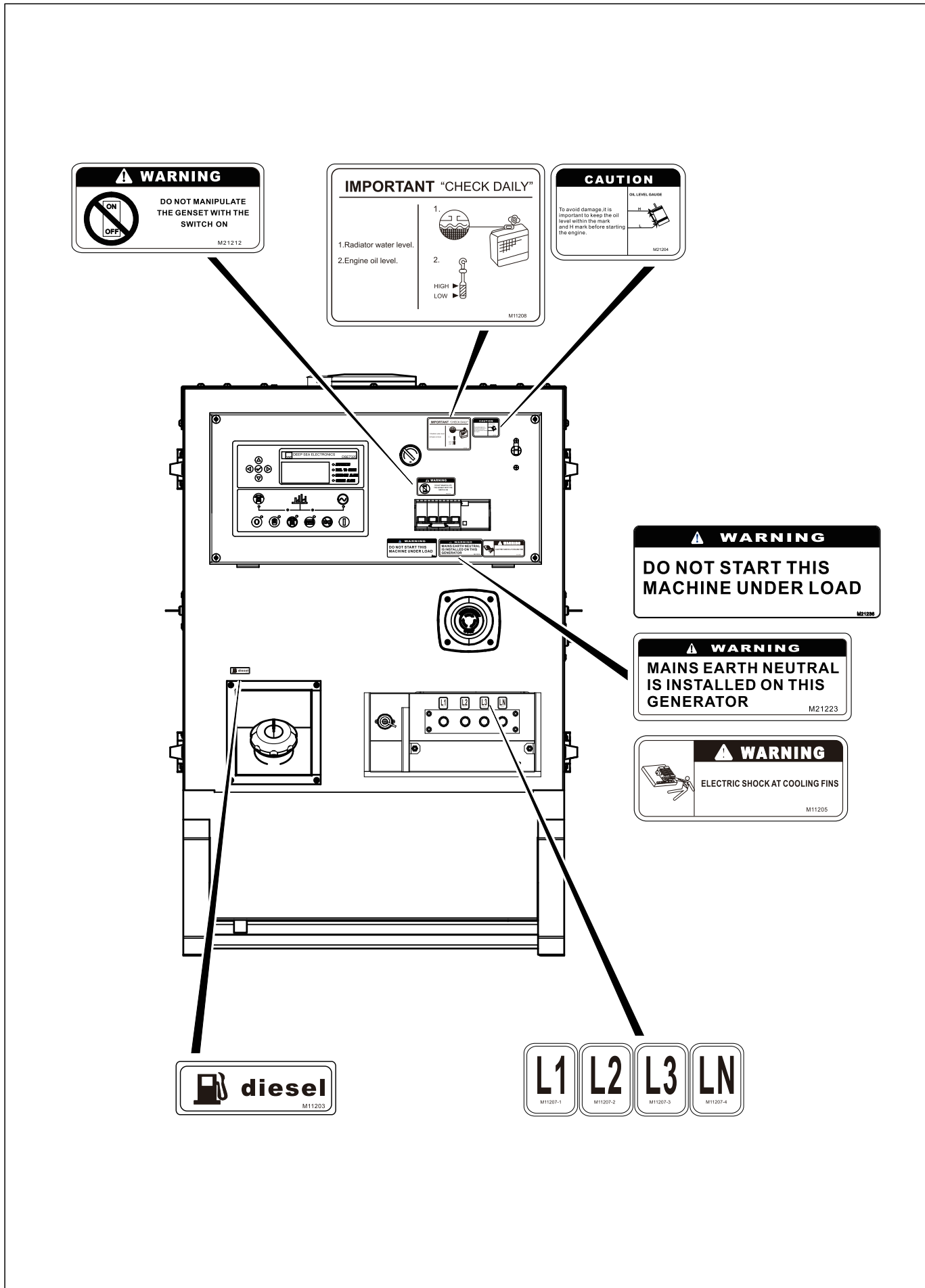

**WARNING**  
DO NOT MANIPULATE THE GENSET WITH THE SWITCH ON  
M21212

**IMPORTANT "CHECK DAILY"**  
1. Radiator water level.  
2. Engine oil level.  
M11208

**CAUTION**  
To avoid damage, it is important to keep the oil level within the mark and fill mark before starting the engine.  
M21204

**WARNING**  
DO NOT START THIS MACHINE UNDER LOAD  
M21228

**WARNING**  
MAINS EARTH NEUTRAL IS INSTALLED ON THIS GENERATOR  
M21223

**WARNING**  
ELECTRIC SHOCK AT COOLING FINS  
M11205

**diesel**  
M11203

**L1** M11207-1  
**L2** M11207-2  
**L3** M11207-3  
**LN** M11207-4



R-type (4-2)

100008597-SO2-A5

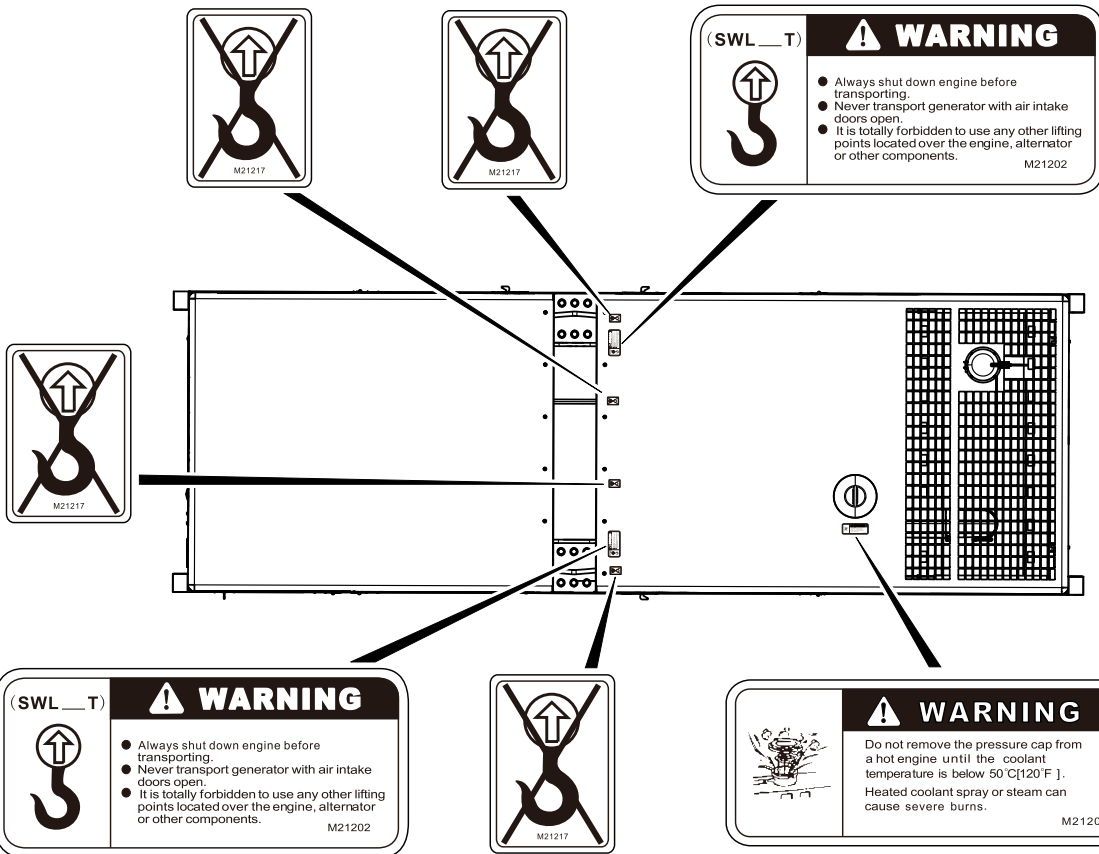
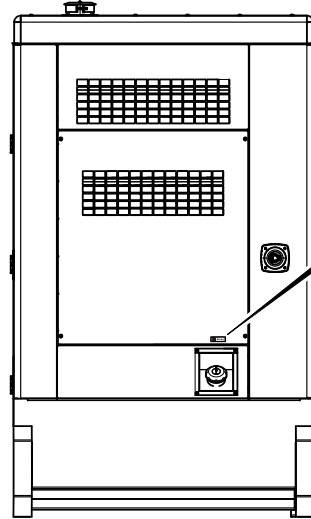

R-type (4-3)

1000008597-SO3-B3

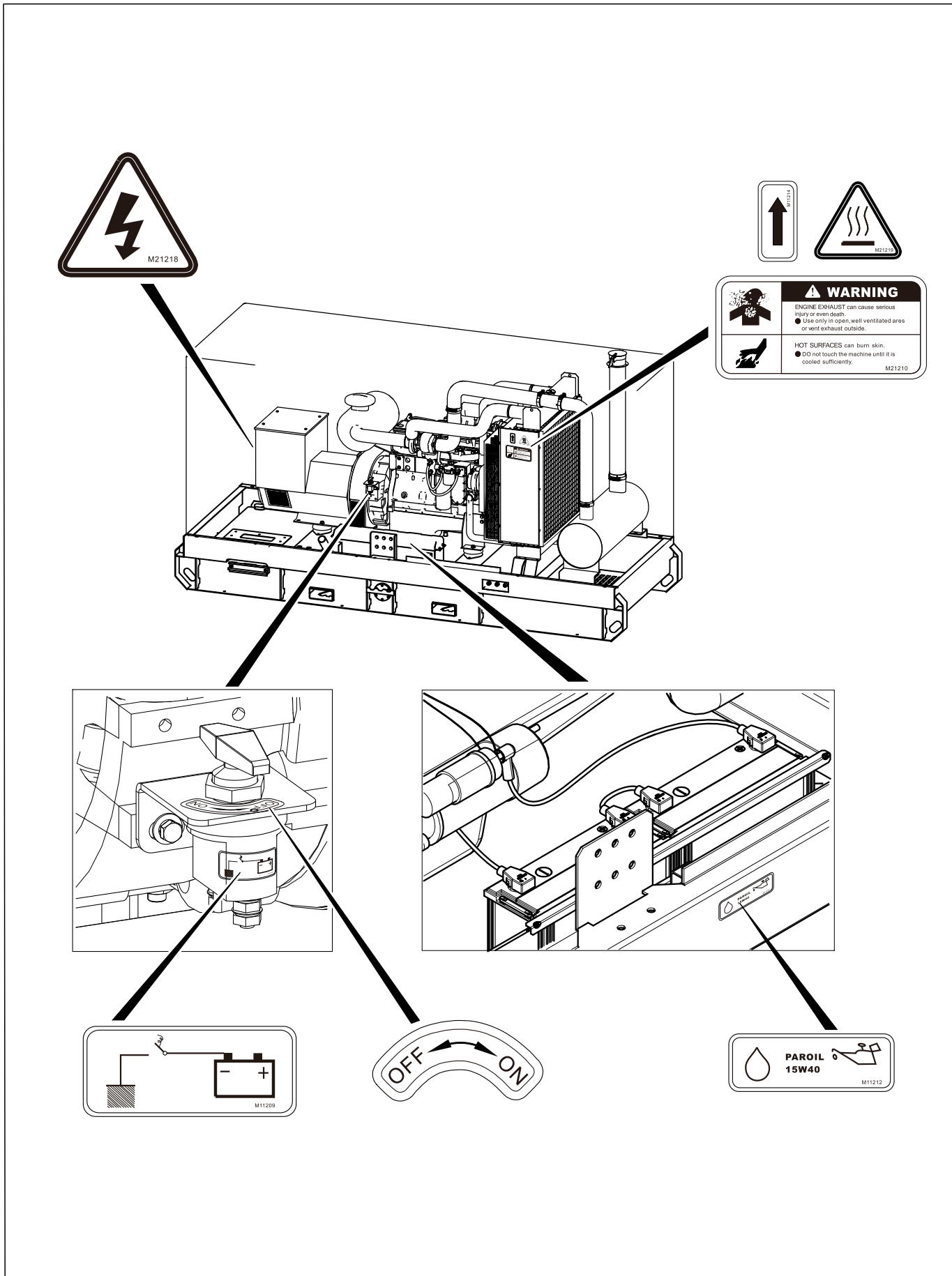

R-type (4-4)

100008597-SO4-B3

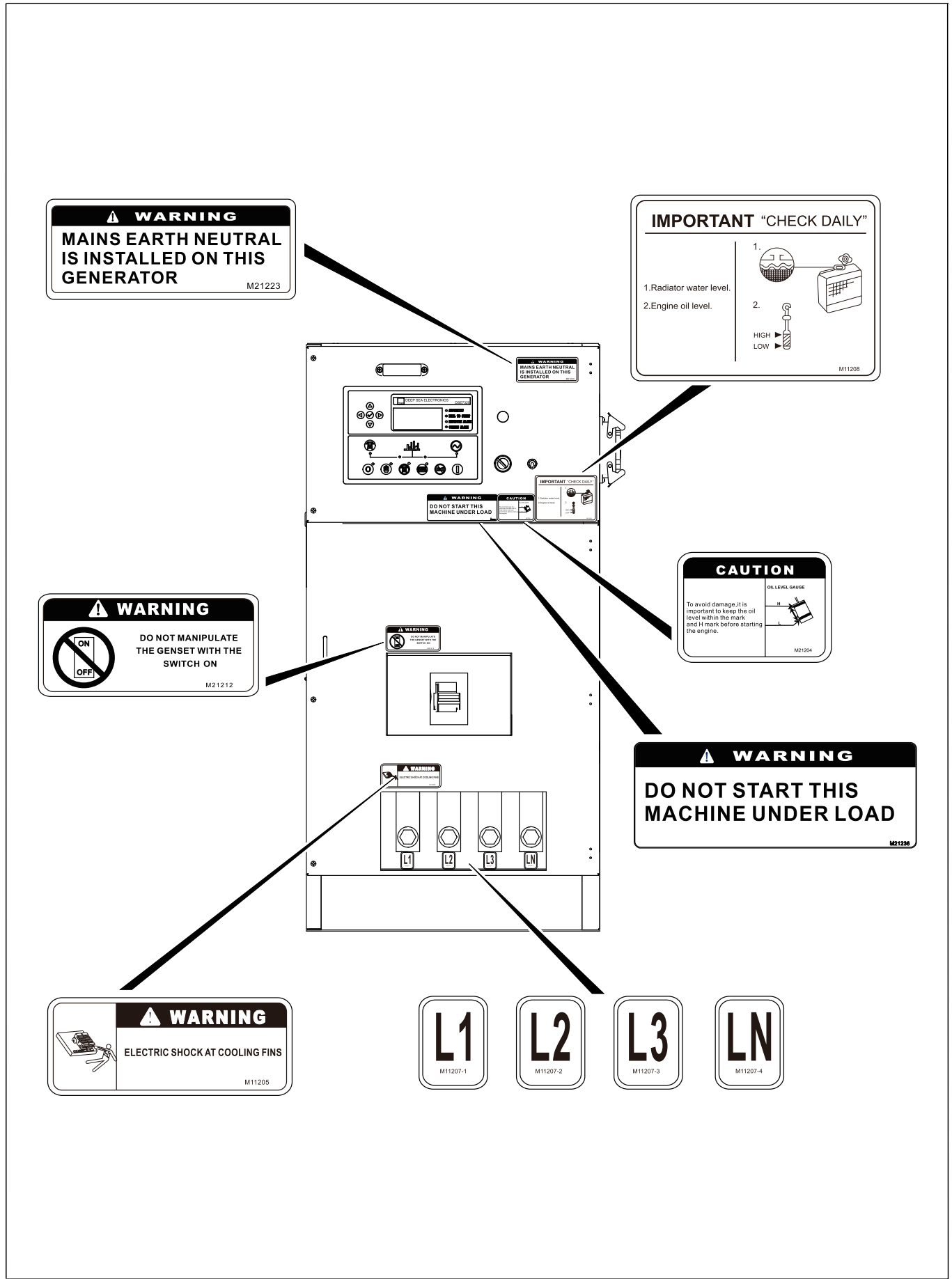

# CHAPTER 1 — SAFETY INFORMATION

## C-type (2-1)

1000020580-SO1-A2

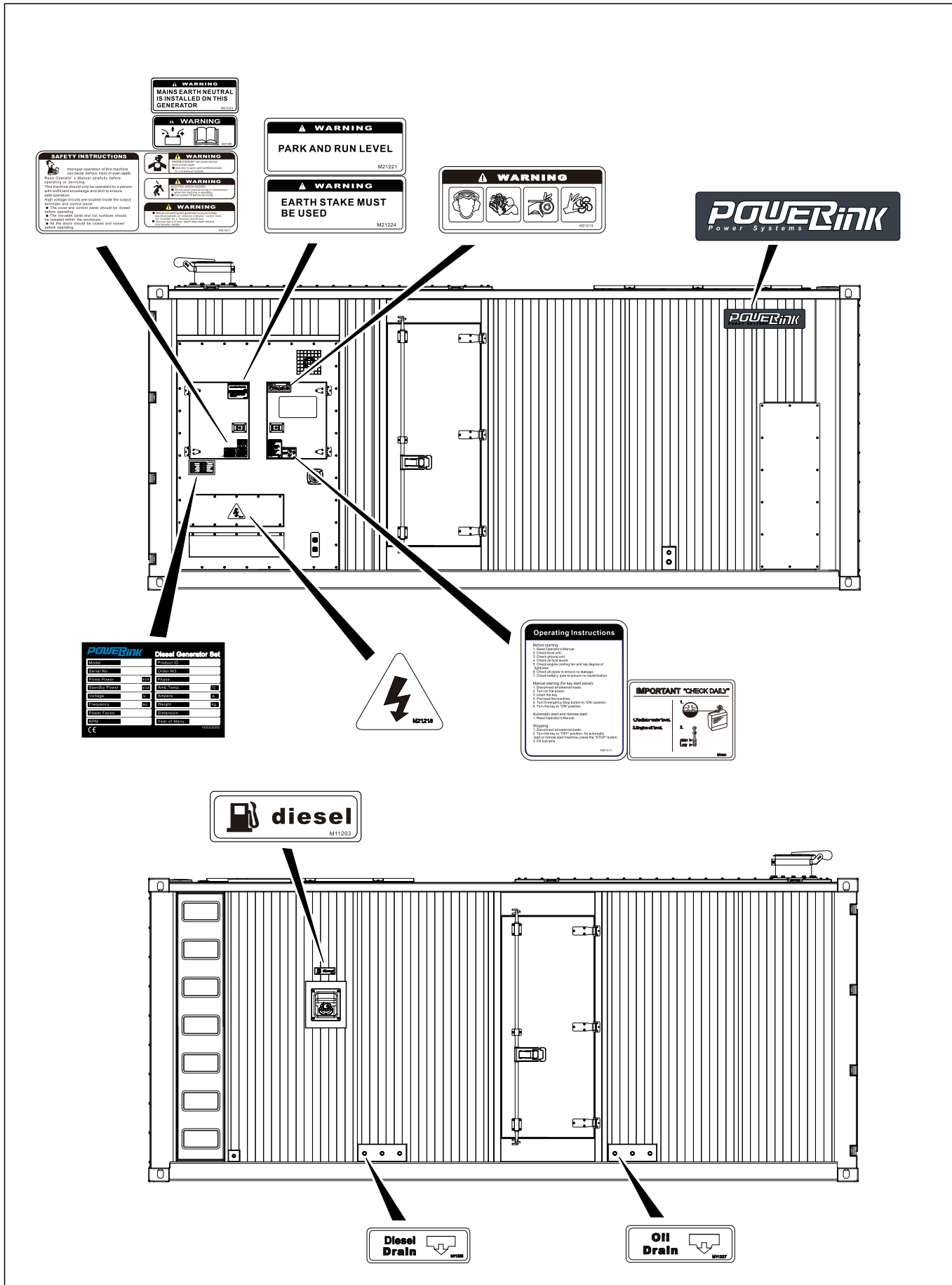

C-type (2-2)

1000020580-SO2-A2

**WARNING**  
**DO NOT START THIS MACHINE UNDER LOAD**  
M21230



**CAUTION**  
 OIL LEVEL GAUGE  
 To avoid damage, it is important to keep the oil level within the mark and H mark before starting the engine.  
M21204

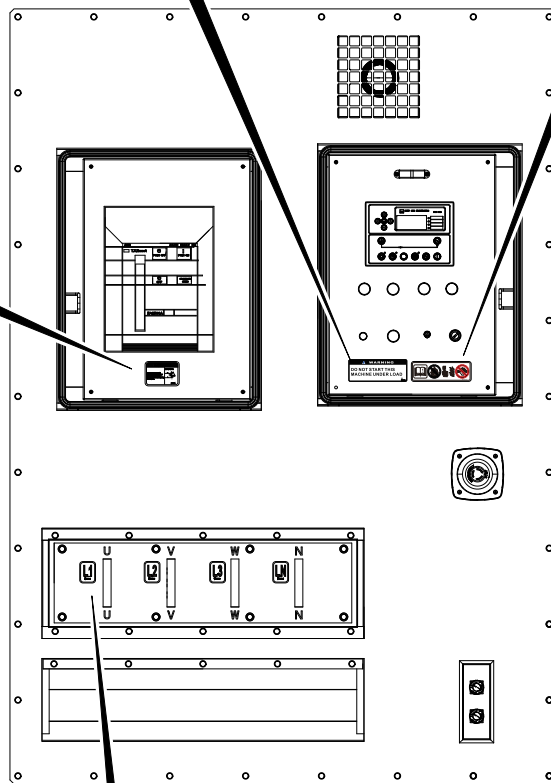

**L1** **L2** **L3** **LN**  
M11207-1 M11207-2 M11207-3 M11207-4

1.3 Safety Label Meaning

**CAUTION**

**Operating Instructions**

Before starting:  
 1. Read Operator's Manual.  
 2. Check level unit.  
 3. Check ground unit.  
 4. Check all fluid levels.  
 5. Check engine cooling fan and rap defree of tightness.  
 6. Check all pipes to ensure no cauterization.  
 7. Check battery pole to ensure no cauterization.

Manual starting(for key start panel):  
 1. Disconnect all external loads.  
 2. Turn on the power.  
 3. Insert the key.  
 4. Pre-heat the machine.  
 5. Turn Emergency Stop button to "ON" position.  
 6. Turn the key to "ON" position.

Automatic start and remote start:  
 1. Read Operator's Manual.

Stopping:  
 1. Disconnect all external loads.  
 2. Turn the key to "OFF" position, for automatic start or remote start machine, press the "STOP" button.  
 3. Fill fuel tank.

M21211

M21211

**CAUTION**

**Before starting:**

1. Read Operation Manual.
2. Check level unit.
3. Check ground unit.
4. Check all fluid levels.
5. Check engine cooling fan and belt tightness.
6. Check all pipes to ensure no cauterization.
7. Check battery pole to ensure no cauterization.

**Manual starting(for key start panel):**

1. Disconnect all external loads.
2. Turn on the power.
3. Insert the key.
4. Pre-heat the machine.
5. Reset the Emergency Stop button.
6. Turn the key to "ON" position.

**Automatic start and remote start:**

1. Refer to Operation Manual.

**Stopping:**

1. Disconnect all external loads.
2. Turn the key to "OFF" position, for automatic start or remote start machine, press the "STOP" button.
3. Fill fuel tank.

**CAUTION**



M21214

M21214

**CAUTION**

- Read the Operation Manual.
- No sparks, flames, or burning objects near the machine.
- Press the emergency stop switch when an emergency occurs.
- Do not dismantle the machine at will.

**CAUTION**

**IMPORTANT "CHECK DAILY"**

1. Radiator water level.

2. Engine oil level.

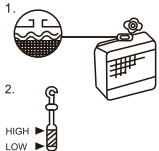

HIGH  
LOW

M11208

M11208

**CAUTION**

1. Radiator water level.
2. Engine oil level.



**WARNING**

**SAFETY INSTRUCTIONS**

Improper operation of this machine can cause serious injury or even death. Read Operator's Manual carefully before operating or servicing. The machine should only be operated by a person with sufficient knowledge and skill to ensure safe operation. High voltage circuits are located inside the output terminals and control panel.

- The cover and control panel should be closed before operating.
- The movable parts and hot surfaces should be isolated within the enclosures.
- All the doors should be closed and locked before operating.

**WARNING**  
CAUTION: Electrical connections should be made only by a qualified electrician.

**WARNING**  
CAUTION: High voltage circuits are located inside the output terminals and control panel.

**WARNING**  
CAUTION: Before connecting the generator to any electrical system in a building, an independent (transfer) power switch must be installed by a licensed electrician.

M21201

## SAFETY INSTRUCTIONS

Improper operation of this machine can cause serious injury or even death. Read Operation Manual carefully before operating or servicing. This machine should only be operated by a person with sufficient knowledge and skill to ensure safe operation. High voltage circuits are located inside the output terminals and control panel.

- The cover and control panel should be closed before operating.
- The movable parts and hot surfaces should be isolated within the enclosures.
- All the doors should be closed and locked before operating.

### WARNING

**ENGINE EXHAUST** can cause serious injury or even death.

- Use only in open, well ventilated areas or vent exhaust outside.

**ELECTRIC SHOCK HAZARD**

- Do not touch internal wiring or connections while this machine is operating.
- Turn power off before servicing.

- Before connecting this generator to any electrical system in a building, an independent (transfer) power switch must be installed by licensed electrician.
- Serious injury or even death may result without this transfer switch.

**CAUTION**

**CAUTION**

To avoid damage, it is important to keep the oil level within the mark and H mark before starting the engine.



OIL LEVEL GAUGE

M21204

M21204

### CAUTION

- To avoid damage, it is important to keep the oil level within the L mark and H mark before starting the engine.

**WARNING**

**WARNING**

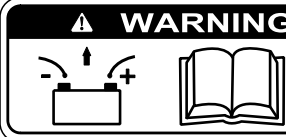

M21208

M21208

### WARNING

- Disconnect battery before servicing.
- Read the Operation Manual for the battery instructions.

**! WARNING**

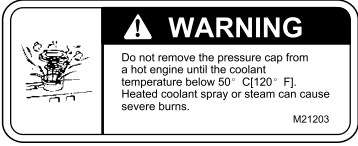

M21203

**WARNING**

- Do not remove the pressure cap from a hot engine until the coolant temperature is below 50°C [120°F]
- Heated coolant spray or steam can cause severe scald.

**! WARNING**



M21213

**WARNING**

Pay attention to following things after opening the access door when the machine is running:

- Wear ear protections.
- Do not inhale exhaust gas from engine.
- Do not touch the pulley on engine.
- Do not touch the cooling fan on engine.

**! WARNING**



M21210

**WARNING**

ENGINE EXHAUST can cause serious injury or even death.

- Use the machine only in open, well ventilated areas or vent exhaust outside.

**WARNING**

HOT SURFACES can burn skin.

- DO not touch the machine until it is cooled sufficiently.

**! WARNING**

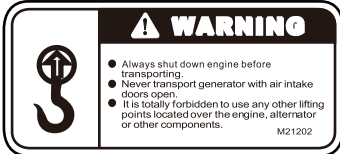

M21202

**WARNING**

- Always shut down engine before transporting.
- Never transport generator with air intake doors open.
- It is totally forbidden to use any other lifting point located over the engine, alternator or other components to lift the whole generator set.

**! WARNING**



M21221

**WARNING**

- PARK AND RUN LEVEL

**! WARNING**



M21236

**WARNING**

- Do not start this machine under load.

**CAUTION**



M21219

**CAUTION**

- Hot surface!

**DANGER**



M21216

**DANGER**

- High Voltage!
- Please don't get close to it when the machine is running.

**WARNING**



M21224

**WARNING**

- Earth stake must be used

**WARNING**



M21212

**WARNING**

- Do not manipulate the genset with the switch on.

**WARNING**



M21223

**WARNING**

- The generator set has been equipped with live, ground and neutral wires.

**WARNING**



M21217

**WARNING**

- Never use it as a lifting lug to lift the whole genset.

**WARNING**



M11214

**WARNING**

- The rotating direction of the cooling fan when it runs.

**NOTE**



M11203

**NOTE**

- Fuel inlet

**NOTE**

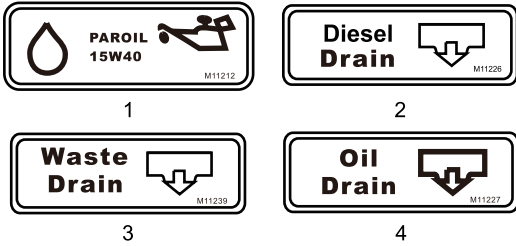

M11212

**NOTE**

- 1、 Engine oil inlet
- 2、 Diesel drain
- 3、 Waste drain
- 4、 Engine oil drain

**NOTE**



M11207

**NOTE**

- Live wires (L1, L2, L3) and neurtal wire (LN)

**NOTE**

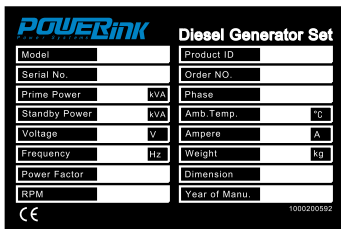

M11250

**NOTE**

- Nameplate of the generator set, there are some main information and parameters about the machine, such as Model, Serial No, Product ID, Ampere, Voltage, Frequency, Dimension and Weight etc.

**NOTE**

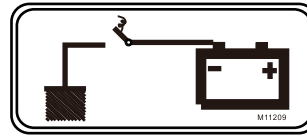

M11209

**NOTE**

- Battery negative switch

**NOTE**



M21205

**NOTE**

- Forklift channel

**NOTE**



M11201

**NOTE**

- Ground bolt; connect it to the ground before starting the machine.

**NOTE**



Logo

**NOTE**

- Logo of the generator set's manufacturer

1.4 First Aid

1



**Occurrence of electric shock**

First aid must be taken in the right way at once to the person who gets an electric shock to the ground by electricity.



2

**Get the victim rid of electricity**

Turn off all the power first if possible and then wear personal protective equipment such as insulating gloves and insulating boots and use special insulating device such as insulating sticks to get the victim rid of the power and far away from the electricity.

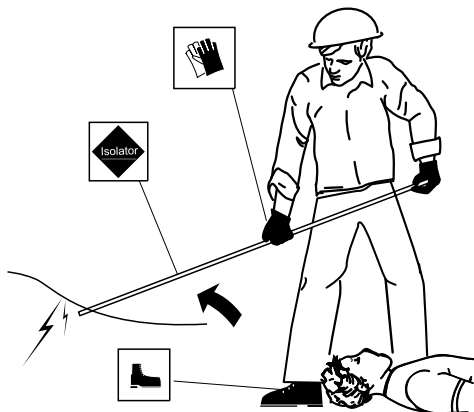

3

**Keep breathing expeditely**

Tilt the victim's head back and raise his/her chin to take the external things such as false teeth and cachou out of his/her mouth to keep breathing expeditely.



4



#### Artificial respiration

Check the breathing status of the victim via looking, listening and feeling. If the victim breathes faintly, artificial respiration should be taken immediately.

During artificial respiration, pinch the victim's nose and seal your lips tightly around the victim's mouth. You should exhale to him/her after deep inspiration every 1~2 seconds.

5

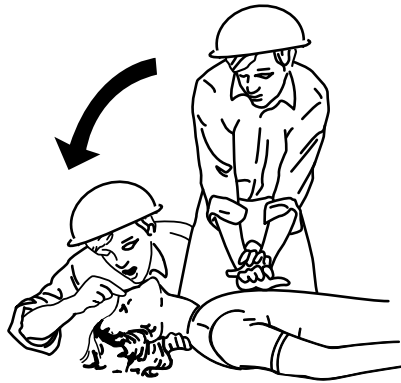

#### Cardiopulmonary resuscitation

If the victim is unresponsive with no breathing or only gasps, CPR should be adopted. When doing CPR, you should press on the victim's chest 80 times per minute to stimulate the action of the victim's heart and do artificial respiration twice after every 15 times of CPR.

6

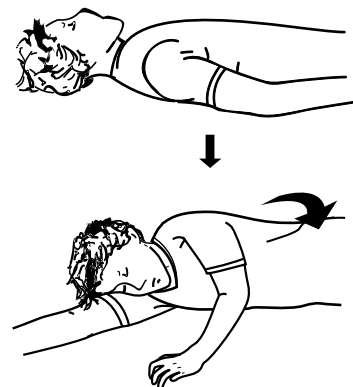

#### In case of the breath recovering

Roll the victim to get him/her lateral to keep him/her breathing expeditely if his/her breath is recovered. Check the victim's breath and pulse at intervals and find out whether there is something unusual occurs. If there is, rescue the victim according to the measures above.

GS-S08

7

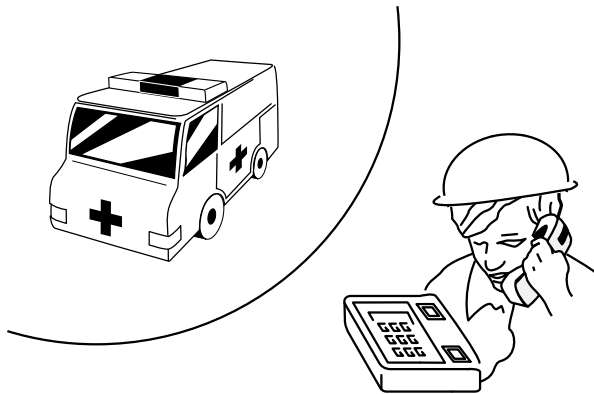

**In case of the breath not recovering**

If the circs isn't going better, call the ambulance for help and keep the other person stay with the victim to watch out for him/her.

8

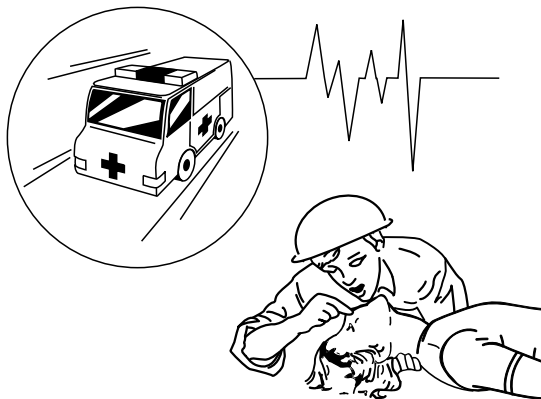

**Before the ambulance comes**

Before the ambulance comes, keep the victim's head tilted back, pinch his/her nose, do artificial respiration every 5 seconds, observe the breathing status of the victim and check carotid pulse every 5~10 seconds. Keep artificial respiration operating if the victim still has a pulse, but is not breathing (respiratory arrest).

# 2 Product Overview

## 2.1 Applications and Features

### 2.1.1 Applications

Generator set is one type of AC power supply equipment, which is driven by diesel engine that drives the synchronous alternator to generate electricity. The genset is used as a power source for three main types of services as follows:

#### (1) Continuous service

Used as a main power to not only provide daily power for families, enterprises, governments etc. in the area which has not yet built up a power grid, but also can build small system of power station through paralleled diesel gensets which can supply power continuously. In this circumstance, the gensets' running hour is not limited.

#### (2) Standby service

Used as standby power supply to provide continue electric power for the area where continuous power supply must be ensured, such as hospitals, industrial facilities, airports etc. Keep the genset in standby state at any time and start to run when the mains supply is abnormal. In this circumstance, the gensets' running hour is 8h at least.

#### (3) Emergency service

Used as auxiliary power supply to solve energy interruptions that may cause serious problems to people, physical and/or financial damage. The genset can start in short time to provide steady electric power for the loads when the mains supply happens abnormality, and switch to stop after the mains supply becomes normal. Generally the genset continues working for a few hours ( $\leq 12h$ ).

### 2.1.2 Features

- High powerful & reliable performance: The powerful Engine (Perkins, Cummins, Volvo, Kubota, Yanmar etc.) and reliable Alternator (Stamford, Leroy somer etc.) ensure reliable and excellent performance of genset.
- Excellent protection class design; the vents with filters preventing the intrusion of rain and dust, applicable in the harsh environment.
- High-grade noise reduction technology and excellent exhaust system can absorb large amount of noise and heat generated in operation, but not affect the habitant environment.
- The genset adopts powder spray processing. With the canopy made of galvanized electrolyte board for car use, it is rustproof for over 5 years. The genset has good corrosion-resistance, and can not be invaded by rain and rust, even if they are violent and strong enough.
- Designed with the drag eyes, lifting rings and fork-lift channels, be convenient for transfer and transport.
- Designed with wide opened access doors to allow easy access for maintenance and repairing.

### 2.1.3 Ambient Condition

- Temperature:  $-25^{\circ}\text{C}$  to  $45^{\circ}\text{C}$  (use the coolant heater below  $5^{\circ}\text{C}$ )
- Humidity: Less than 80%
- Altitude: Less than one thousand (1000) meters

2.2 Product Family

GS-IT2

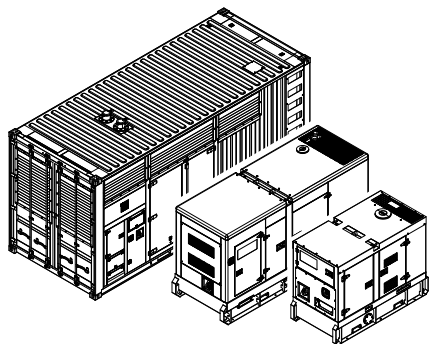

Soundproof type

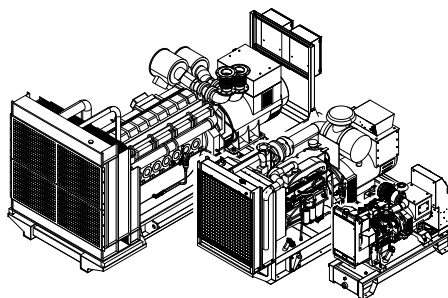

Open type

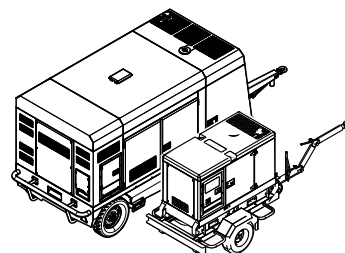

STATIONARY

PORTABLE

EV series

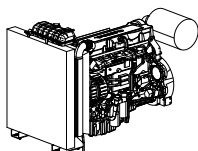

Volvo Engine

EC series

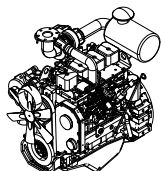

Cummins Engine

EP series

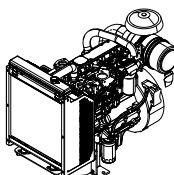

Perkins Engine

RP series

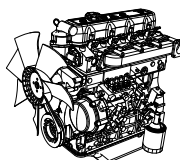

Powerlink Engine

RK series

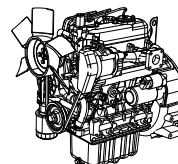

Kubota Engine

RY series

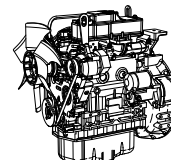

Yanmar Engine

Note: all series can provide the genset of 3-phase or 1-phase, 50Hz or 60Hz .

Nameplate

Product Model      Product Serial No.

		<b>Diesel Generator Set</b>	
Model	Serial No.	Product ID	Order NO.
Prime Power      kVA	Standby Power      kVA	Phase	Amb.Temp.      °C
Voltage      V	Frequency      Hz	Ampere      A	Weight      kg
Power Factor	RPM	Dimension	Year of Manu.
CE		1000200592	

Technical Parameters

Technical Parameters

Manufacture Date

### 2.3 Structure

GS-IT4

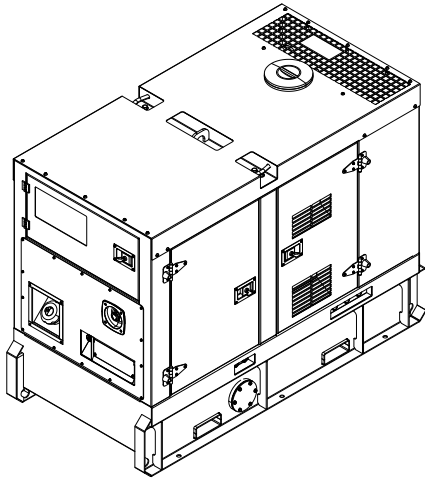

#### RS Type

- Output power range: 5-20kVA.
- Equipped with fuel tank for 8h running at least, used as standby or emergency power service.
- Excellent sound-proof technology, noise at 7m < 65 dBA.
- Supremely compact configuration & easy operation.

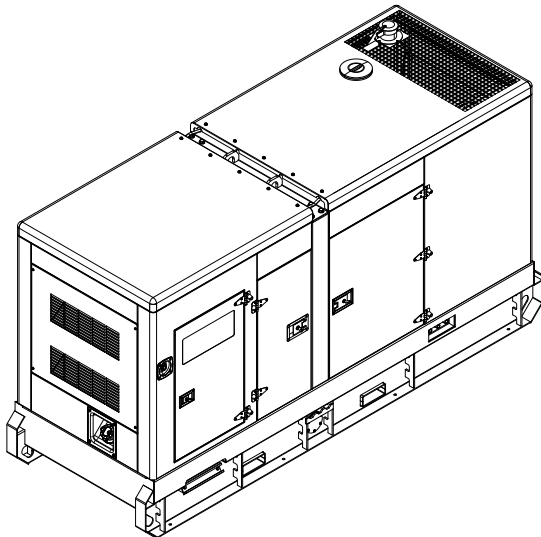

#### R Type

- Output power range: 5-625kVA.
- Equipped with fuel tank for 8h running at least, not just used as standby or emergency but also continuous service.
- Excellent sound-proof technology, noise at 7m < 75 dBA.
- Compact configuration & easy operation.
- Steady performance and long service life.

#### C Type

- Output power range: 725-2000kVA.
- Equipped with fuel tank for 8h running, coupled with external fuel tank, which can be used as continuous, standby or emergency service.
- Excellent sound-proof technology, noise at 7m < 85 dBA.
- Container configuration & easy transport.
- Powerful output is suitable for heavy loads

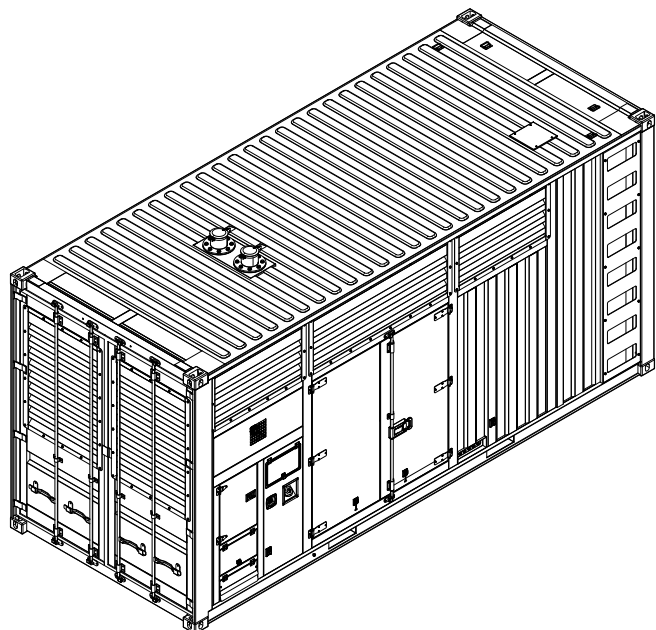

## 2.4 Function of Major Components

Modern generator set is a mini power station which is driven by the diesel engine. Generally speaking, it contains the diesel engine, alternator and control system. The engine drives the alternator to produce output electrical power while the control system controls the operation and output of the genset and protects the machine from possible malfunctions. Besides, the genset also includes accessories such as the control panel, switch cabinet, radiator, fuel tank, battery for startup and control, protective device, muffler and base frame.

### (1) Diesel Engine

The diesel engine powers the generator set and the genset's performance relies heavily on its quality. We choose engine for its superior performance and reliability and the fact that it has been specifically designed for powering the generator set.

### (2) Cooling System

The engine cooling system is either air cooled or water cooled. The air cooled system consists of high capacity fan to pull cool air across engine to cool it. The water cooling system is comprised of radiator, pusher fan and a thermostat. The alternator cooling system is air cooled which consists of a fan to pull cool air across alternator to cool it.

### (3) Engine Electrical System

The engine electrical system is 12 (or 24) volt DC electricity whose negative pole is earthed. It consists of the start motor, battery and battery charger. The positive pole of battery connects to start motor and the negative one connects to battery switch.

### (4) Fuel Tank & Base Frame

The engine and alternator are coupled together and mounted on a heavy duty steel base frame. This base frame includes a fuel tank with a capacity of approximately 8 hours (or 24 hours) operation at full load.

### (5) Vibration Isolator

The generator set is fitted with vibration isolators which are designed to reduce engine vibration being transmitted to the foundation on which the generator set is mounted. These vibration isolators are fitted between the engine/alternator feet and the base frame.

### (6) Alternator

The alternator produces and outputs electrical power. We choose alternator for its superior performance and reliability. All the standard alternators are the machines without carbon brush, wound as "2/3 pitch", with class H insulation. We apply STAMFORD or LEROY SOMER or other brand according to the customer's requirement.

### (7) Control System

We provides 4 types of control system, PLC-920, PLC-7420/7320, PLC-8610, PLC-IG-NTC, PLC-AGC242 and PLC-AGC3. In addition, we could also customize other control system according to the customer's requirement. The PLC-920 and PLC-7420/PLC-7320, are for single genset applications while PLC-8610, PLC-IG-NTC, PLC-AGC242 and PLC-AGC3 are for grid connected genset applications. All the control systems are designed to automatically start and stop generator set and provide excellent genset monitoring and protection features.

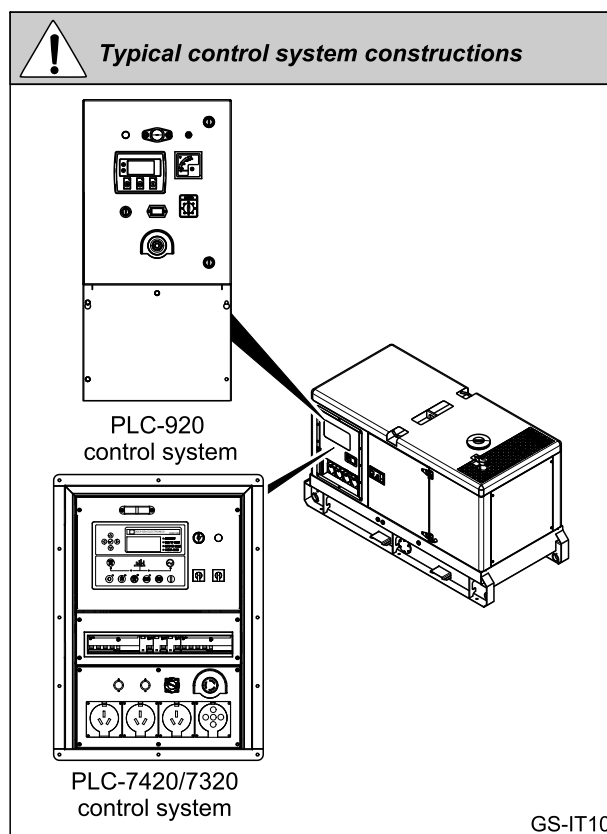

GS-IT10

2.5 Component Identification

RS type generator set:

1000019425-IT2-A1

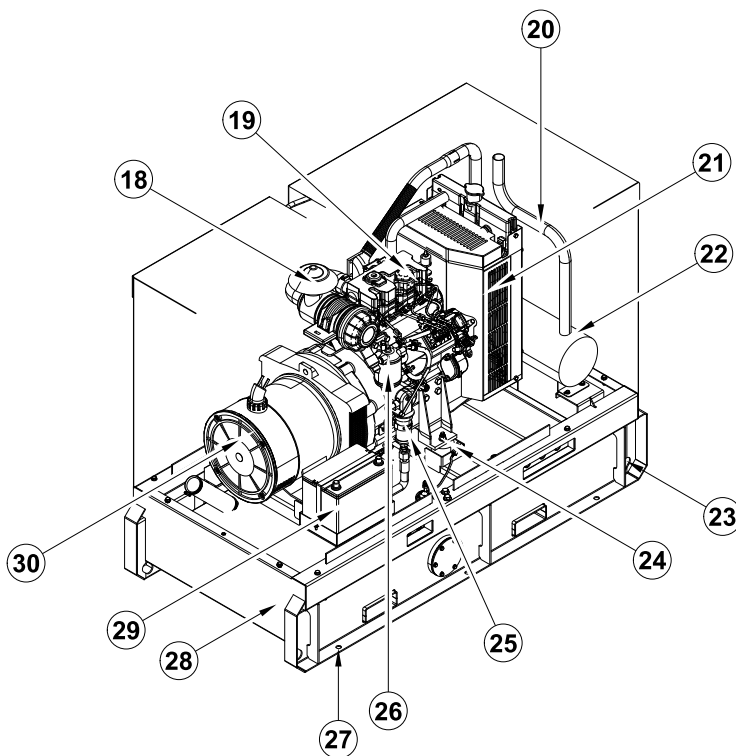
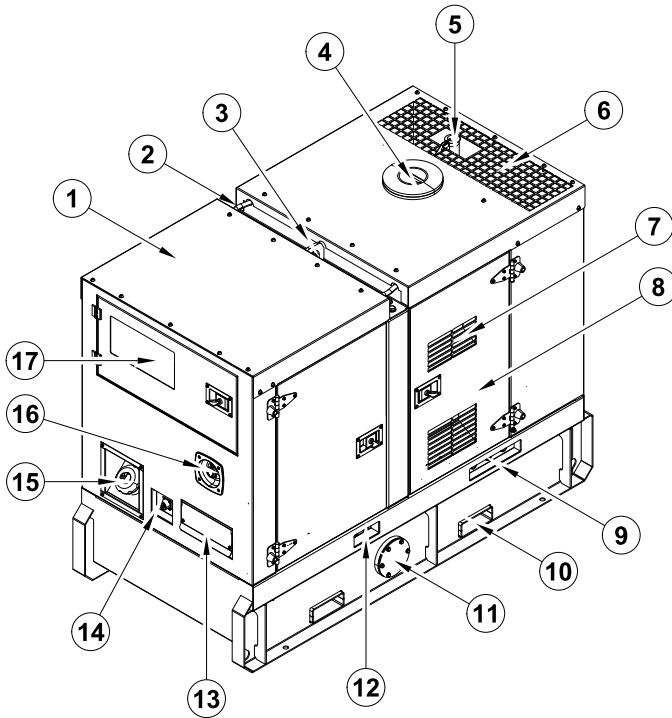

- ① Soundproof canopy
- ② Roping lug
- ③ Lifting lug
- ④ Coolant inlet
- ⑤ Exhaust outlet
- ⑥ Air outlet
- ⑦ Air inlet
- ⑧ Access door
- ⑨ Oil/water drain
- ⑩ Fork lift channel
- ⑪ Fuel drain
- ⑫ Connector for external fuel tank
- ⑬ Field wiring cabinet
- ⑭ ATS/remote control receptacle
- ⑮ Fuel inlet
- ⑯ Emergency stop button
- ⑰ Control cabinet
- ⑱ Air cleaner
- ⑲ Engine
- ⑳ Exhaust pipe
- ㉑ Radiator
- ㉒ Muffler
- ㉓ Dragging hole
- ㉔ Vibration isolator
- ㉕ Oil pump
- ㉖ Fuel filter
- ㉗ Mounting hole
- ㉘ Base frame
- ㉙ Battery
- ㉚ Alternator

R type generator set:

1000008445-IT2-A3

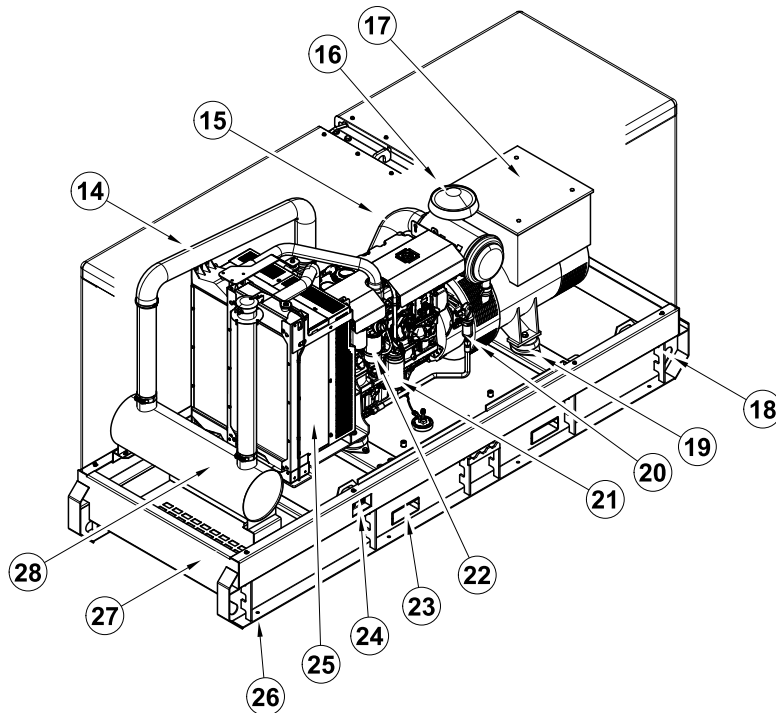
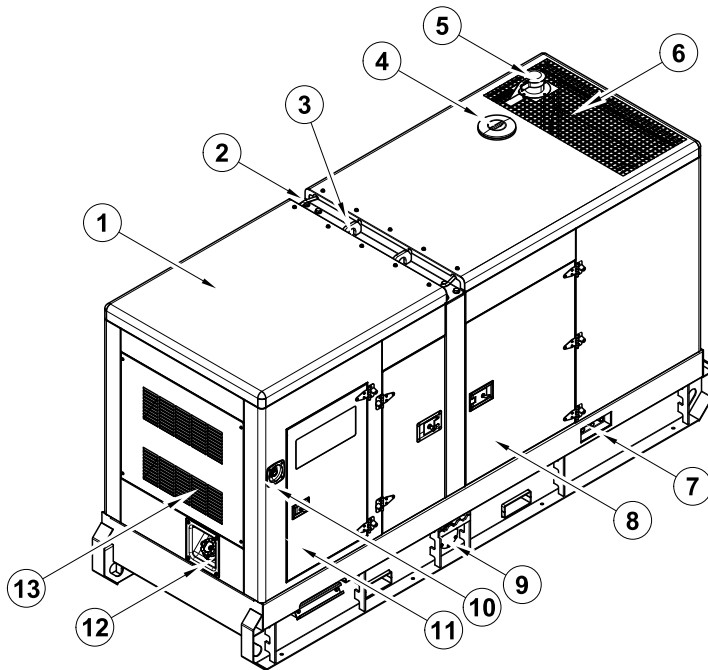

- ① Soundproof canopy
- ② Roping lug
- ③ Lifting lug
- ④ Coolant water inlet
- ⑤ Exhaust gas outlet
- ⑥ Air outlet
- ⑦ Oil/water drain
- ⑧ Access door
- ⑨ Fuel drain
- ⑩ Emergency stop button
- ⑪ Control cabinet
- ⑫ Fuel inlet
- ⑬ Air inlet
- ⑭ Exhaust pipe
- ⑮ Engine
- ⑯ Air cleaner
- ⑰ Alternator
- ⑱ Dragging hole
- ⑲ Vibration isolator
- ⑳ Oil pump
- ㉑ Oil filter
- ㉒ Fuel filter
- ㉓ Fork lift channel
- ㉔ Connector for external fuel tank
- ㉕ Radiator
- ㉖ Mounting hole
- ㉗ Base frame
- ㉘ Muffler

## C type generator set:

1000022142-IT2-G5

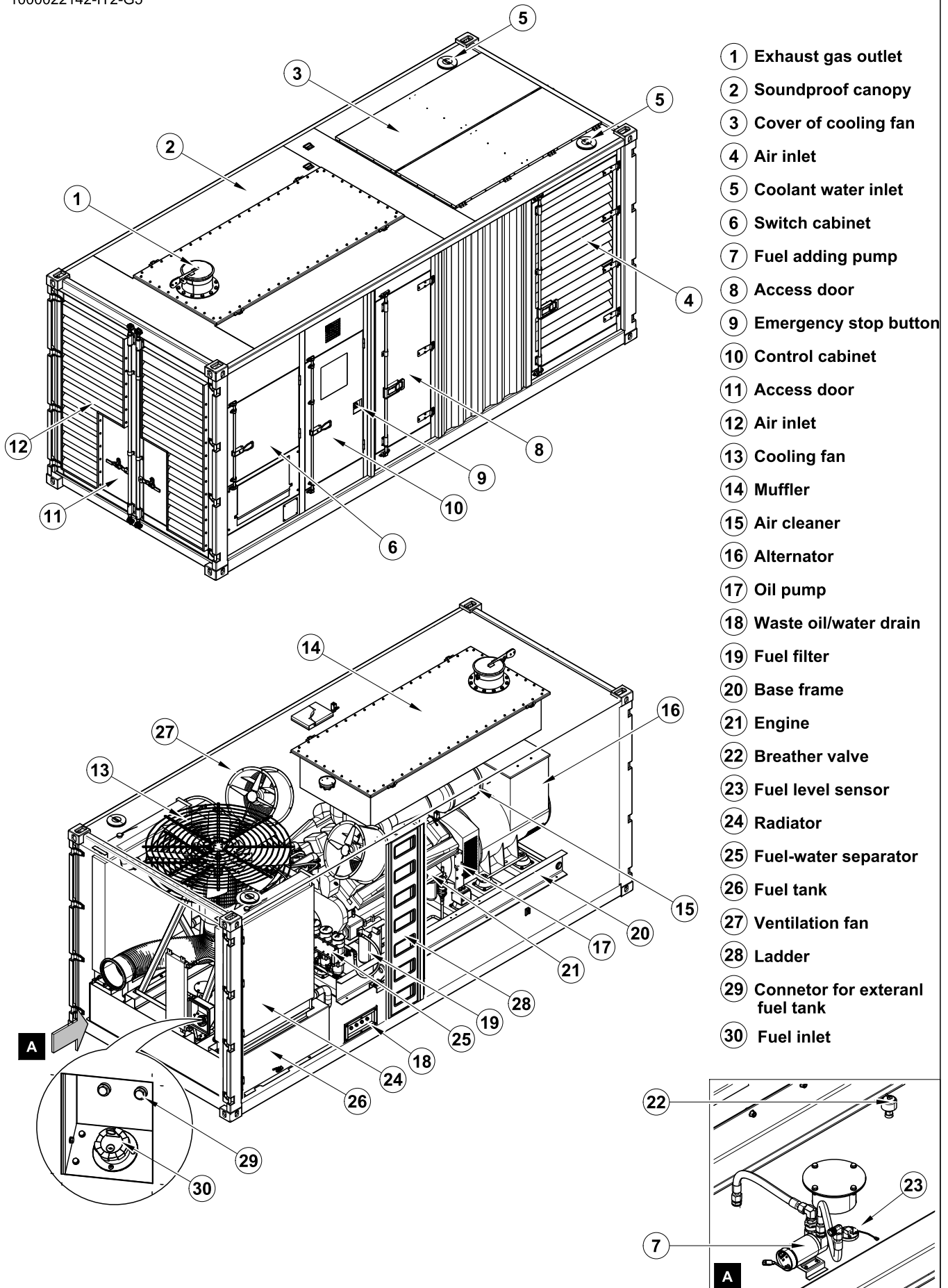

## 3 Installation

### 3.1 General Inspection Prior to Installation

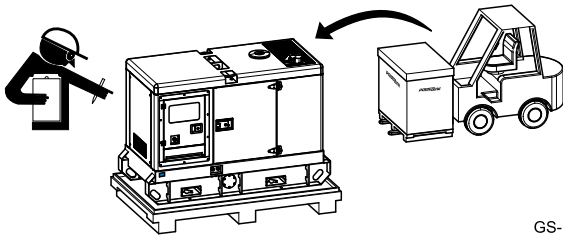

GS-IN1

The delivery scope depends on your order. Prior to commissioning, please check whether all required parts have been provided. Please check the order confirmation for any possible accessory equipment.

The standard product provides technical documents as follows:

- *Certificate of conforming.*
- *Test report.*
- *Operation manual.*
- *Wiring diagram.*
- *The documentation of engine & alternator.*

**POWERLINK** also provides parts list, specifications, engineer handbook etc. Contact **POWERLINK** for complete information or technical support through the website, phone, fax, or email if you encounter a problem when using your product or product documentation.

**CAUTION**

GS-IN3

Each generator set has been thoroughly inspected prior to shipment from the factory. However, be sure to check for damaged parts or components during transportation, or loose nuts and bolts, which could have occurred in transit.

- *Ensure all safety labels are legible and in place. Clean or replace as required if necessary.*
- *Check all surfaces for leakage (oil, fuel or battery fluid). Report any leakage to the proper maintenance personnel.*
- *Inspect the machine structure to ensure there is no crack or other discrepancies in the profile of the machine, welding leg or the body.*

### 3.2 Outdoor Installation Requirements

**CAUTION**

GS-IN3

The soundproof type and container type generator set whose canopy is designed to minimize noise, keep out undesirable weather elements and providing cooling and inside ventilation, can be installed outdoors. In addition, make sure the location you selected satisfies the following requirements:

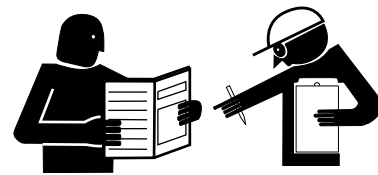

GS-IN4

- *The generator set should be installed in an area that is protected from direct harmful gases or liquid, dust, metallic particles, shock and vibration.*
- *The generator set should be mounted on a flat, smooth, noncombustible level surface. A concrete pad is ideal and provides a secure installation.*
- *Access must be provided to allow the soundproof canopy or control cabinet to be opened or removed for service and maintenance.*
- *Installation should prevent water level from reaching the genset. Drainage must be adequate to drain standing water from the installation foundation.*
- *Installation should prevent obstructions by a buildup of leaves, grass, sand, snow etc. If these items pose a problem, consider building a small fence or other break to protect the unit from accumulation of debris.*
- *At least 1.2 meters (47.5 inches) clearance must be provided on all sides for air flow. And be careful, the exhaust gas pipe and hot air exhaust pipe can't face the doors or windows of the buildings.*
- *The safe bearing capability of the geological material should be carefully evaluated when selecting a location for installation.*

3.3 Outdoor Installation Instructions

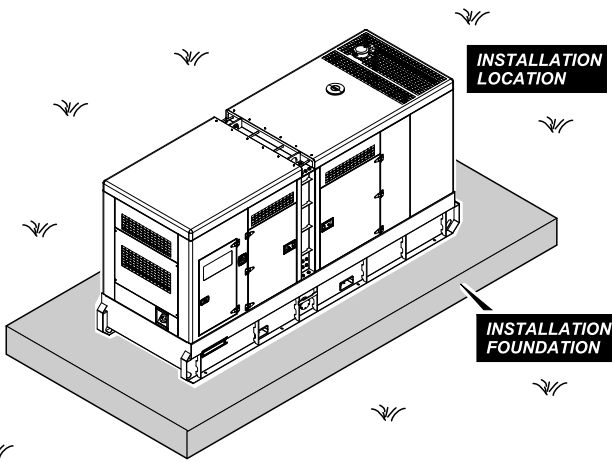
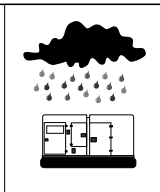

**WARNING**

**1. Select Installation Location**

The installation location should be flat, smooth, noncombustible and level.

The safe bearing capability of the geological material should be carefully evaluated when selecting for the location. Please refer to the formula and details below:

$$SAFE\ BEARING\ CAPACITY > SBL = \frac{9.81TW}{L \times W} \times 10^{-6}$$

SBL— Bearing capacity of the foundation (MPa )

TW— Weight of the genset and foundation (kg)

L— Length of the foundation (m)

W — Width of the foundation (m)

Geological Material	Safe Bearing Capability(MPa)
Granite	2.394~9.575
Oil shale	0.961~1.432
Rock	0.765~0.961
Soft rock	0.481~0.962
Tamped gravel	0.481~0.579
Pebble and gravel	0.383~0.481
Tamped sandy clay	0.284~0.383
Sandy clay	0.196~0.383
Sand	0.098~0.196
Soft clay	<0.098

**2. Build Installation Foundation**

Never use rigid connection between the foundation and Location.

The surface of the foundation should be oil-water proof (concrete is a good choice), and equipped with drainage.

Foundation Dimensions(mm)			
Length	Width	Depth	Height
Genset Length + 300	Genset Width + 300	≥B	≥150

$$B = \frac{2M}{W \times L \times \rho} \times 1000$$

B — Depth of foundation (m)

M — Weight of genset (kg)

ρ — Density of concrete (2322 kg/ m<sup>3</sup>)

L — Length of foundation (m)

W — Width of foundation (m)

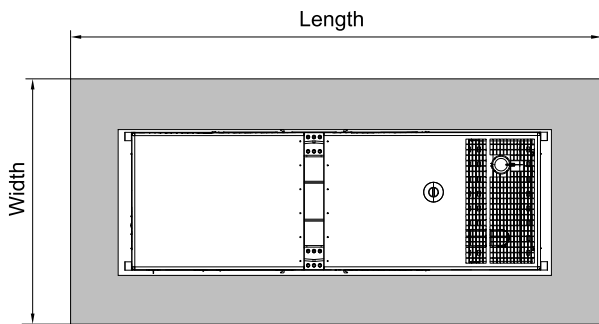
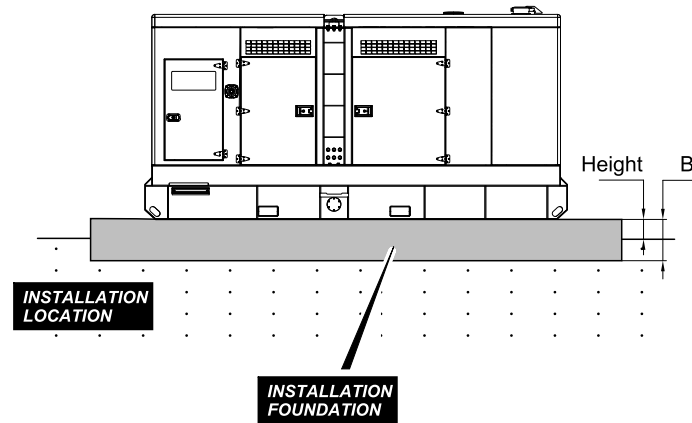



**WARNING**

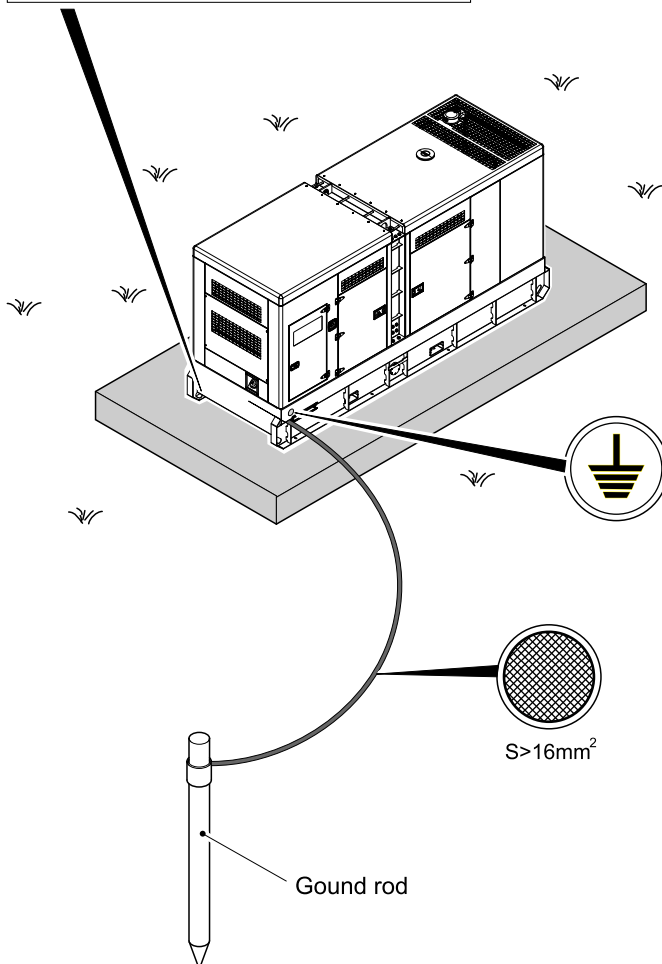
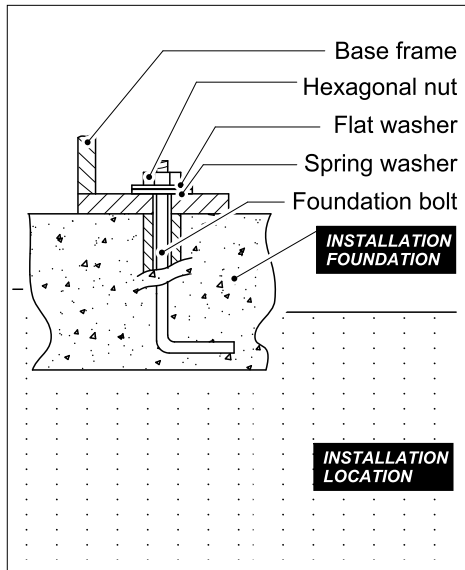

**WARNING**

### 3. Generator Set Fixation

Fix the base frame of the genset with foundation bolts before using the machine.

Each foundation bolt needs to use a hexagonal nut, flat washer and spring washer. The amount and dimension of foundation bolts should be decided by the installation hole of the base frame.

### 4. Generator Set Grounding

The metal parts of the generator set may be with some charge due to insulation flaw or other reasons and cause an electric shock. So these must be connected to the ground.

The genset and electric components have been equipped with their respective grounding terminals which are all connected to the ground bar in the control cabinet. The ground bar is connected to the ground bolt on the base frame. Connect the ground bolt to the ground rod, and insert the rod into the ground before use.

The ground rod should be buried at a minimum depth of 20cm into the ground.

The cross section of ground wire should be not less than 16 mm<sup>2</sup>.

### 3.4 Indoor Installation Requirements



GS-IN3

#### 3.4.1 Room Requirements

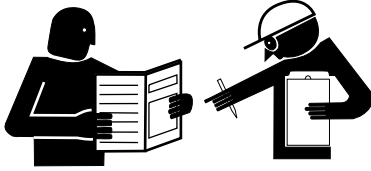

GS-IN4

The lightning, vibration, ventilation, fire, lighting and environment protection factors should be carefully evaluated when the generator set is installed indoors.

##### (1) General Requirements

- *If the genset room is equipped with control room, observational window should be set in the wall between the two rooms. The doors of genset room and control room should be fire/sound-proof and opened outside, while the door between the two rooms should be opened towards the genset room.*
  - *If the genset room is located in the main building, the wall and roof should be built with high density materials (surface density at least 700kg/m<sup>2</sup>) and the windows should be double-glazed.*
  - *Usually the ground is polishing cement and it could prevent oil infiltrating.*
  - *The genset room should be near the power distribution management location.*
  - *The genset room should not be located in the living area or buildings that are occupied by people or animals. Never allow exhaust gas towards any opening or air entry routes (doors, windows, vents etc.) of an occupied building directly. If it is unavoidable, keep the distance between them at least 8 meters. In addition, it is not suitable to set the air inlet and outlet in the meeting room or other places which requires quiet.*
  - *Keep the genset room are clear and ventilated. Never store the goods that flammable, explosive and corrosive.*
- *Assure the genset room has 1 or 2 doors. At least one of the doors is big enough for transporting the machine.*
  - *The channel equipped with drainage should be designed in the room for laying cables or ducting. The channel should be covered by steel plate or concrete pad.*

**(2) Lightning & Electrostatic Protection**



GS-IN5

- *The lightning protection should be carefully evaluated when the genset room is designed. If the room is located in the building, the lightning protection rating should be equal to that of the main building.*
- *If the genset uses external fuel transported by pipelines, the fuel lines should be grounded.*
- *Metal parts of installations or structures of the genset room, such as water pipe, vent pipe, steel door(window) frame, shutter and etc, which are exposed to human contact, and due to an insulation flaw or other reason, may get in contact with voltage, must be grounded.*

**(3) Fire Protection**



GS-IN6

- *The genset room should be provided with the fire extinguisher. Recommend equipping the room with automatic fire alarm system & automatic fire protection system.*

**(4) Noise Reduction**



GS-IN36

- *The soundproof type generator set's noise achieves 65 to 85dBA @ 7m. Keep the genset room away from the place where needs quiet as far as possible and recommend equipping the room with noise insulation and absorption devices.*

3.5 Indoor Installation Instructions

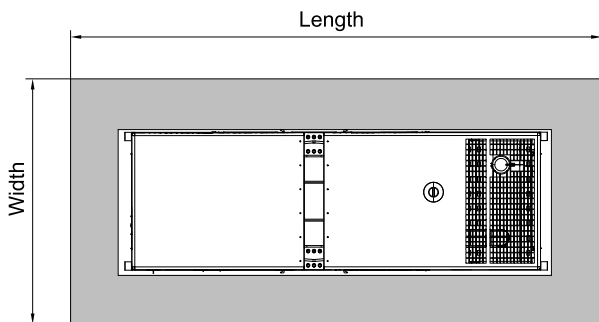
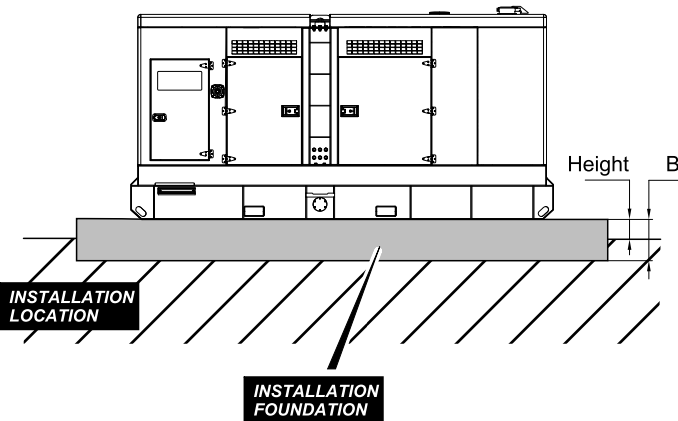
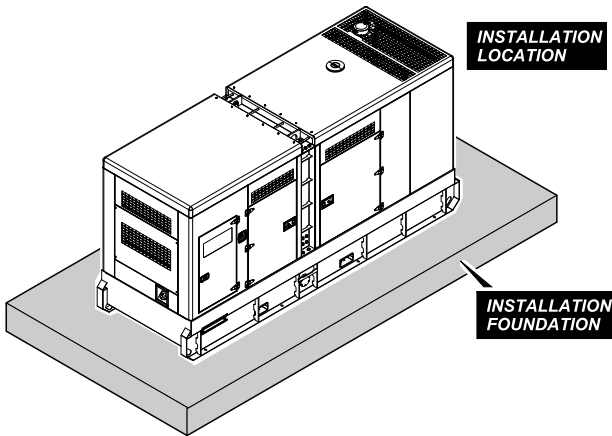
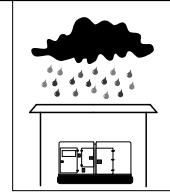

**! WARNING**

**1. Select Installation Location**

The installation location should be flat, smooth, noncombustible and level.

If the genset is set on the floor, the load bearing capacity of the floor should fit the static or dynamic load of the genset.

The safe bearing capability of the geological material should be carefully evaluated when selecting for the location. Please refer to the formula and details below:

$$SAFE\ BEARING\ CAPACITY > SBL = \frac{9.81TW}{L \times W} \times 10^{-6}$$

SBL— Bearing capacity of the foundation (MPa)

TW— Weight of the genset and foundation (kg)

L— Length of the foundation (m)

W — Width of the foundation (m)

Geological Material	Safe Bearing Capability(MPa)
Granite	2.394~9.575
Oil shale	0.961~1.432
Rock	0.765~0.961
Soft rock	0.481~0.962
Tamped gravel	0.481~0.579
Pebble and gravel	0.383~0.481
Tamped sandy clay	0.284~0.383
Sandy clay	0.196~0.383
Sand	0.098~0.196
Soft clay	<0.098

**2. Build Installation Foundation**

Never use rigid connection between the foundation and Location.

The surface of the foundation should be oil-water proof (concrete is a good choice), and equipped with drainage.

Foundation Dimension(mm)			
Length	Width	Depth	Height
Genset Length + 300	Genset Width + 300	≥B	≥150

$$B = \frac{2M}{W \times L \times \rho} \times 1000$$

B — Depth of foundation (m)

M — Weight of genset (kg)

ρ — Density of concrete (2322 kg/ m<sup>3</sup>)

L — Length of foundation (m)

W — Width of foundation (m)

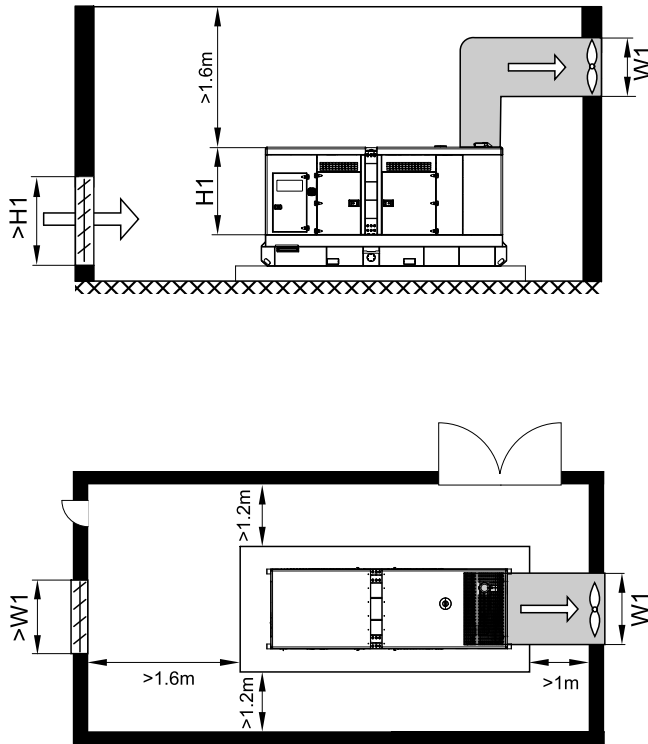
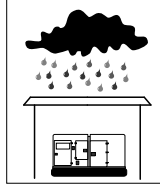

**! WARNING**

**3. Generator Set Room Requirements**

The size of room and cooling air ventilation should be carefully considered when the generator set is installed indoors.

- Enough space must be provided to allow the access door or control cabinet to be opened or removed for service and maintenance in the room.
- It is advisable to set up the shutters in the air inlet and outlet to protect the generator set from bad weather. The page plate can be fixed, but movable one is preferred. Close the shutter to keep the room warm if the generator set is not in use when the weather is cold. It is helpful to start the generator set and add loads next time.

**! WARNING**

*The engine of this generator requires an adequate free flow of fresh air.*

**NEVER** operate the generator in any enclosed or narrow area where free flow of air is restricted. If the air flow is restricted it will cause serious damage to the generator engine and may cause personal injury.

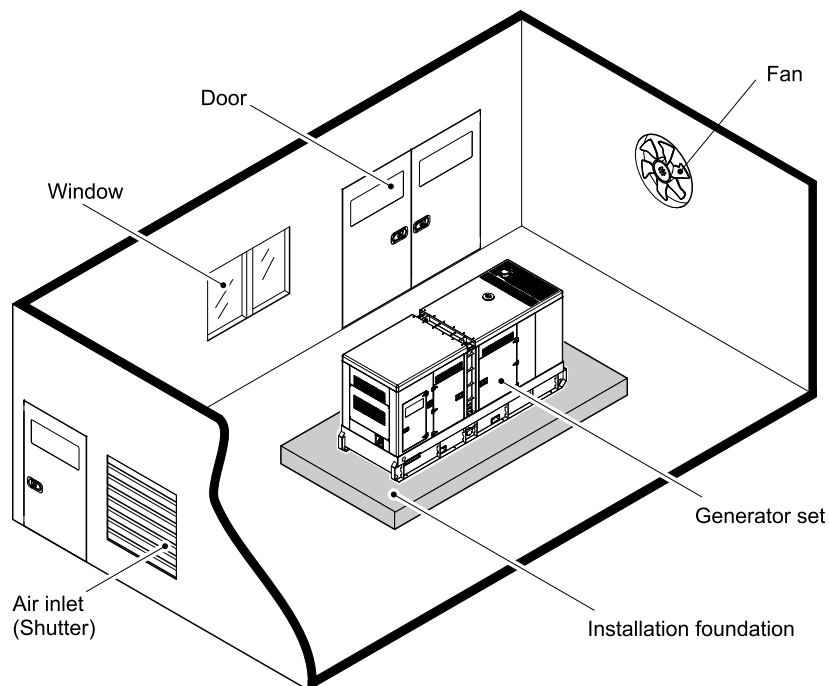



**WARNING**

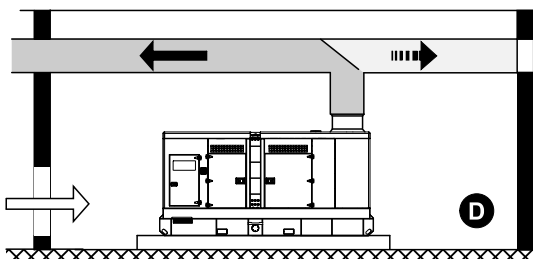
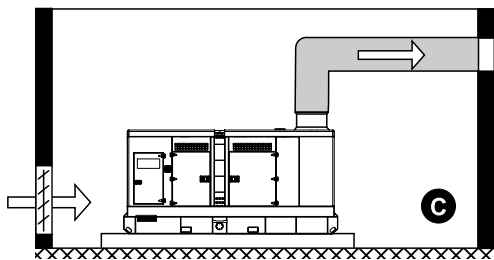
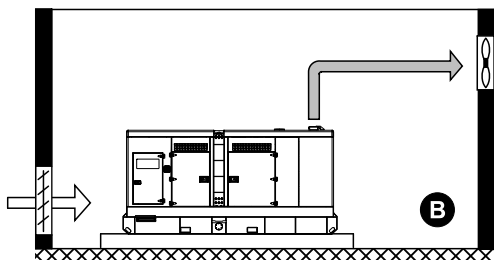
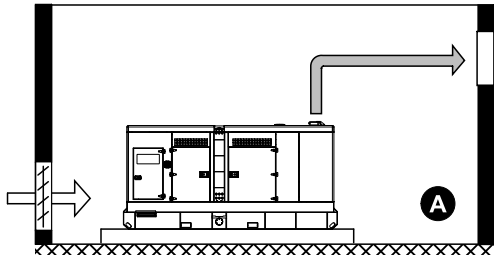
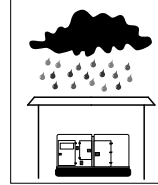

**WARNING**

#### 4. Ventilation requirements



**Attention!** Arrange the generator set intake openings or ducts such, so that dangerous admixtures (e.g. explosive or chemically unstable materials) cannot be drawn in.

- Arrange supply air openings close to the floor.
- Arrange exhaust air openings in the ceiling or at the top of the wall.
- The required cross sections for the supply openings (as well as for the cover and protective hood) are indicated in former figure "GS-IN9".
- Ensure that the flow rates in the ducts do not exceed 16 km/h.
- Never position air ducts directly on the generator set. Always use a compensator to avoid distortion and the transfer of vibration.

**A:** Supply and exhaust air openings in the outside walls (free-standing installation)

**B:** Supported by exhaust air fan.

**C:** Exhaust air duct into the open.

**D:** Using the hot exhaust air for heating.

In winter, the hot exhaust air is used for room heating. In summer it is directed into the open.

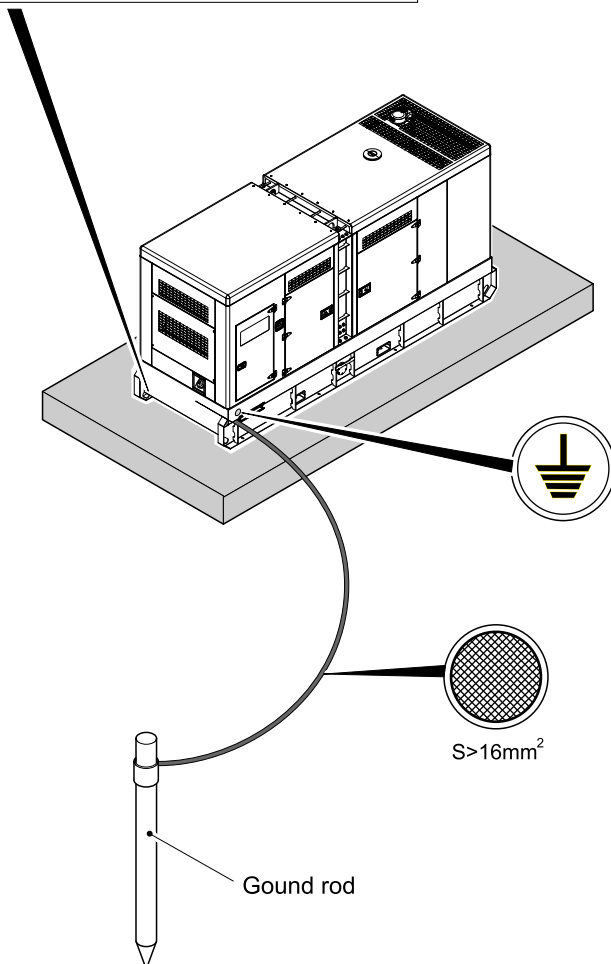
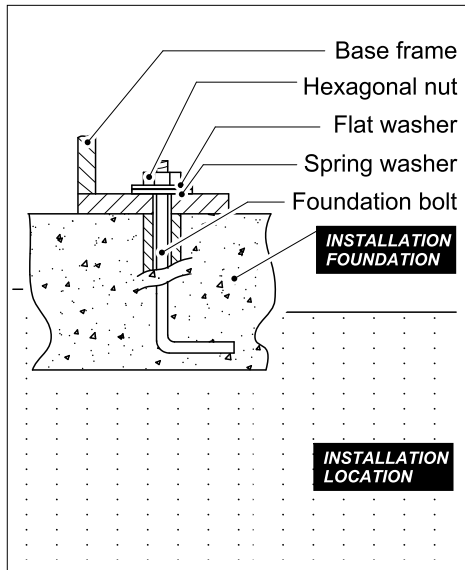
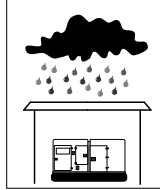

**! WARNING**

**5. Generator Set Fixation**

Fix the base frame of the genset with foundation bolts before using the machine.

Each foundation bolt needs to use a hexagonal nut, flat washer and spring washer. The amount and dimension of foundation bolts should be decided by the installation hole of the base frame.

**6. Generator Set Grounding**

The metal parts of the generator set may be with some charge due to insulation flaw or other reasons and cause an electric shock. So these must be connected to the ground.

The genset and electric components have been equipped with their respective grounding terminals which are all connected to the ground bar in the control cabinet. The ground bar is connected to the ground bolt on the base frame. Connect the ground bolt to the ground rod and insert the rod into the ground before use.

The ground rod should be buried at a minimum depth of into the ground.

The cross section of ground wire should be not less than than 16 mm.

## 3.6 Battery Connections



**WARNING**

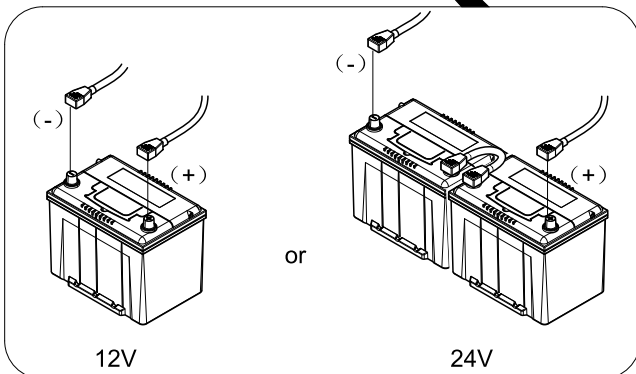
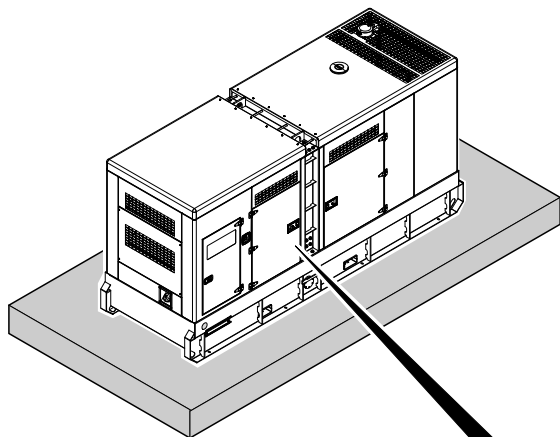

**WARNING**

### Battery connections

The battery cables should be disconnected to the posts when the genset is required to transport or store for a long term. Before running the machine, connect the battery cables.

Connect the red cable to the positive (+) post, and the black cable to the negative (-) post.



*Connect negative (-) battery cable last.*

GS-IN12

3.7 External Fuel Tank Connections (if applied)



**WARNING**

**CAUTION**

The 3-way ball valve on the base frame ( if applied) is used for connecting the engine fuel system to an external fuel tank.

After finishing the fuel system distribution, the operator could select the fuel supply between the genset's fuel tank and external fuel tank through operating the 3-way ball valve.

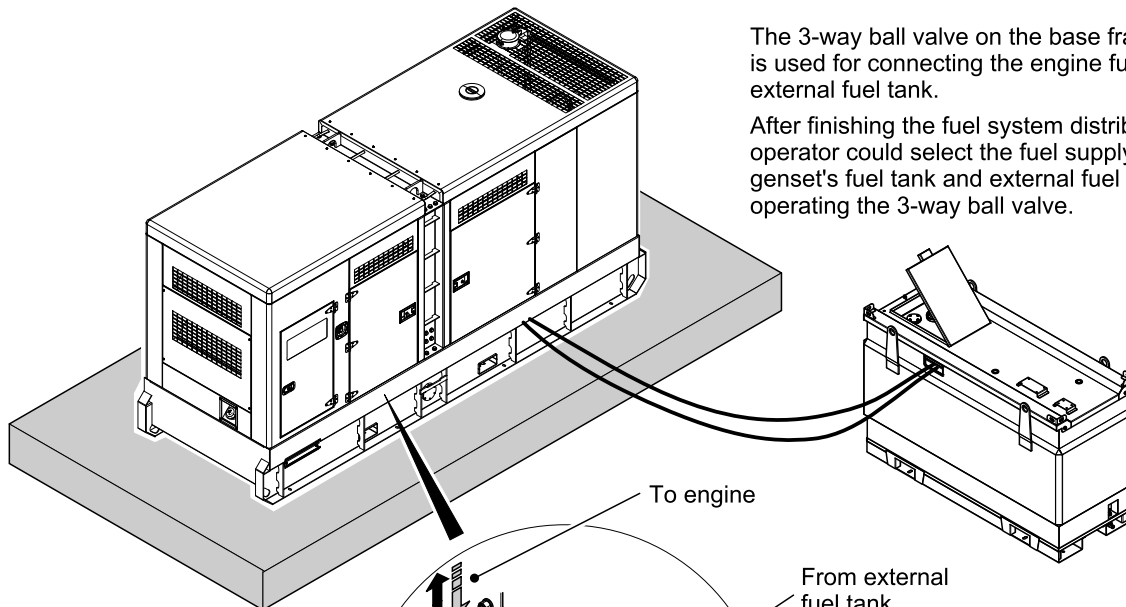

← Fuel inlet  
 ← Fuel return

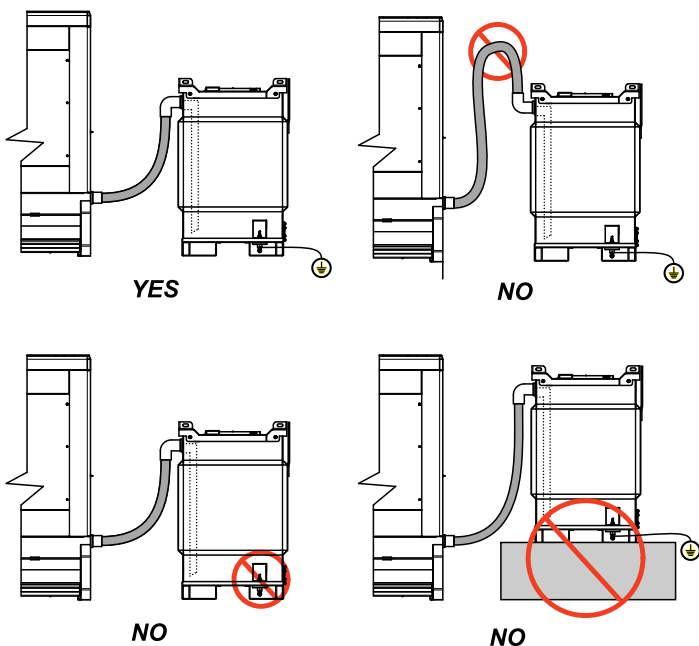
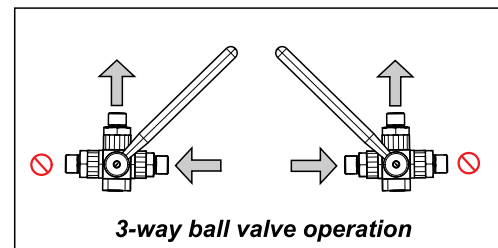

- 1) Set the 3-way valve on the base frame.
- 2) Connect the genset's fuel inlet and return hoses to the 3-way valve.
- 3) Connect the external fuel inlet and return hoses to the connection plugs which are located on the side of base frame.
- 4) Connect the engine's fuel inlet and return hoses to the 3-way valve.
- 5) Select the fuel source by operating the 3-way valve.

**WARNING**

**DO NOT** route hose above external fuel tank connection, or loop or kink hoses. This will cause air locks in the hose and block circulation of the fuel.

Make sure the external fuel tank has been grounded for the fuel is flammable and explosive.

Make sure the external fuel tank and generator set are mounted on the same level.

3.8 Auto Fuel Adding Connections (if applied)

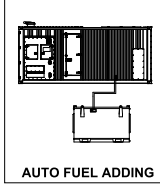

**CAUTION**

The standard containerized generator set is equipped with auto fuel adding system which includes fuel pump, control box and correlative hoses. The connection points are located on the side of canopy. The user may connect the fuel hoses of external fuel tank through these points.

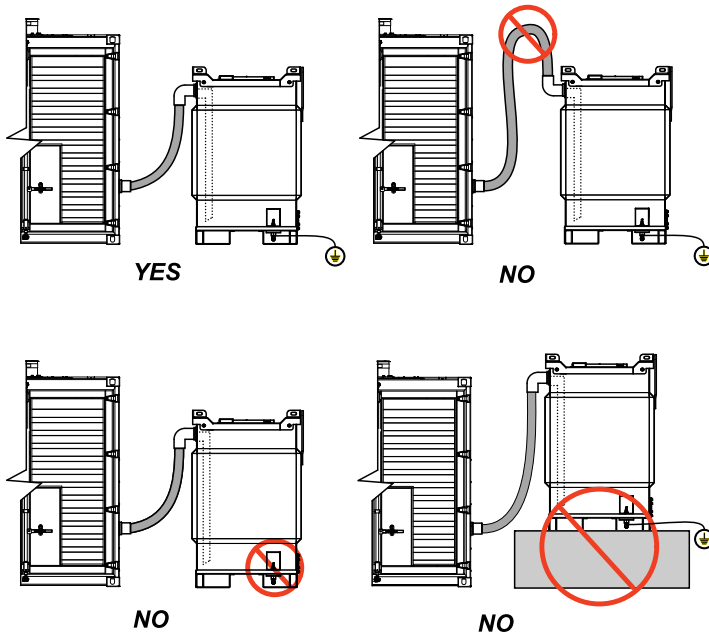
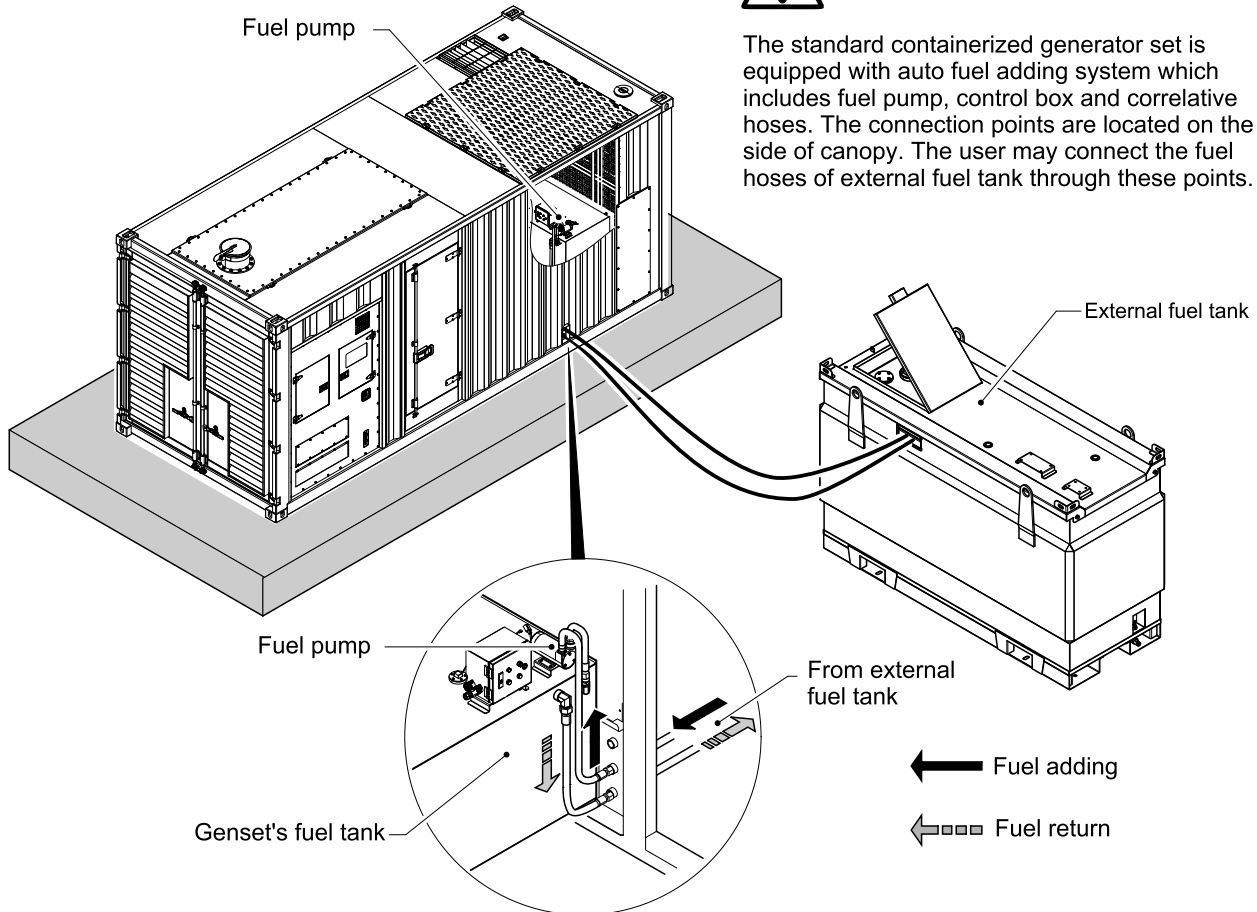

- 1) Check and make sure the connections of fuel hoses inside the generator set are correct.
- 2) Connect the external fuel inlet and return hoses to the connection plugs which are located on the side of canopy.

**WARNING**

**DO NOT** route hose above external fuel tank connection, or loop or kink hoses. This will cause air locks in the hose and block circulation of the fuel.

Make sure the external fuel tank has been grounded for the fuel is flammable and explosive.

Make sure the external fuel tank and generator set are mounted on the same level.

### 3.9 Generator Set Electricity Connections



**WARNING**

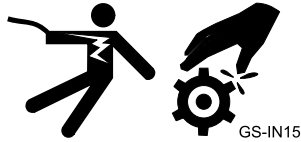

GS-IN15

#### WARNING: Risk of injury!

Always adhere to the prescribed operating method described below for all setting work. Never break a single safety rule! Otherwise you will risk injury from restarting, electric shock or parts which may fly off.

#### Setting work operation rules



**CAUTION**



GS-IN16

- Ensure that setting work is only carried out by specialists or appropriately trained persons.
- Ensure that no setting work on the generator set is undertaken until these operating instructions are understood.
- Wear protective equipment such as safety glasses, leather gloves, heavy shirt and trousers and high shoes when working on generator set.
- Connecting of parts and components under current is prohibited.
- Ensure all insulating and grounding connections are in accord with requirements.
- Prior to setting work:
  - Switch off the main switch (both generator set's and mains's) and secure it against unintentional switch-on.
  - Switch off the battery switch of the generator set and secure it against unintentional switch-on.

#### 3.9.1 Loads Connections



**WARNING**



GS-IN17

#### STOP THE GENSET FIRST!

Loads can be connected to the generator by the Power Output Terminals or the convenience receptacles. Make sure to read the operation manual and switch ALL circuit breakers to the OFF position before attempting to connect a load to the generator.

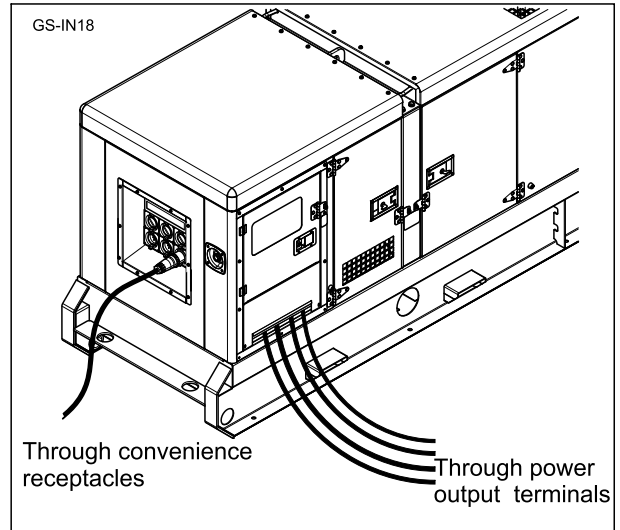

#### Load Cables Selection

Select the cable with proper diameter, based on its allowable amperage and the distance between the genset and the load. There is maximum 5% marginal drop only for the rated voltage between the terminals of loads and genset via the cables. It should be considered while selecting the cable.

Cable Selection			
Current (A)	Minimum cross-sectional area (mm <sup>2</sup> )	Current (A)	Minimum cross-sectional area (mm <sup>2</sup> )
9	0.5	78	16
12	0.75	105	25
14	1	130	35
18	1.5	155	50
25	2.5	200	70
33	4	250	95
42	6	290	120
58	10	335	150

\* NOTE: If the current exceeds the allowable amperage of single cable, parallel multi cables to satisfy the demand through the connection points on the power cable terminal.



**CAUTION**

GS-IN3

- If load exceeds allowable amperage, the cable may be damaged for overheating.
- If the cable is either too long or it's cross-sectional area is too small, there will be greater voltage drop between cables which bring voltage drop to loads. It will cause serious damage to the connected loads.

## Through Power Output Terminals

The power output terminals are located at the bottom of the control cabinet. The terminals provide connection points for attachment of outside loads.

Connections to the terminals should be made by running the power cables up through the slots in the bottom of the control cabinet and into the terminals.

Remove lockable nut from power output terminal. Slide power cable terminal onto power output terminal and secure with nut so that power cable terminal is tight against power output terminals (The figure below shows two types of representative power output terminal connections).

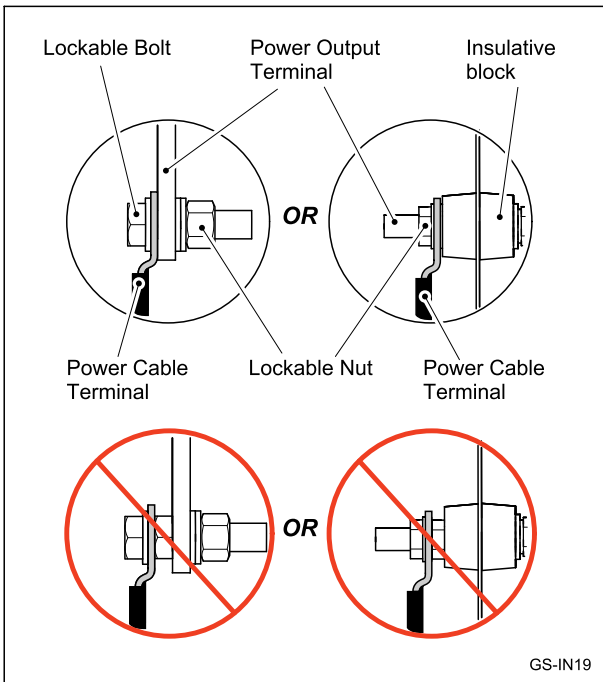

## Through Convenience Receptacles (if applied)

Usually the convenience receptacles are located in the output receptacle cabinet.

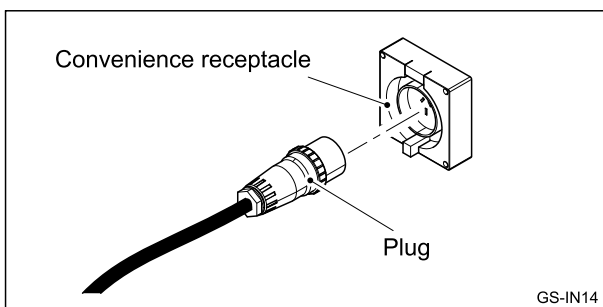

### 3.9.2 Remote start and AMF/ATS Communication Connections

The connector (4 or 9 pin) is located in the control cabinet which provides connection points for installation of a remote start switch. When it is connected to a transfer switch, it allows the generator to be used as a standby power supply.

There are 2 types of configuration for remote start and AMF/ATS communication connections in

the standard product. The connector(s) of these 2 types is(are) located in the bottom of control cabinet.

#### • 9 pin connector

In this circumstance, all the communication connection points are integrated in one 9 pin connector. The user could distribute the communication wiring according the generator set's wiring diagram.

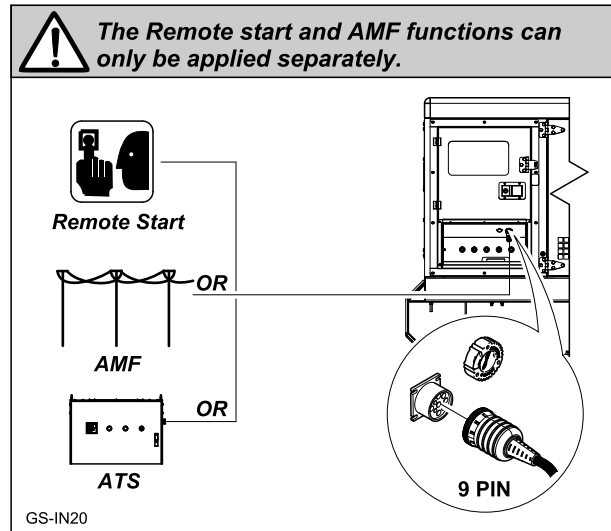

#### • 9 pin and 4 pin connectors

In this circumstance, 4 pin connectors provides communication connection points for remote start while 9 pin connectors provides communication connection points for AMF/ATS. The user could distribute the communication wiring according the generator set's wiring diagram.

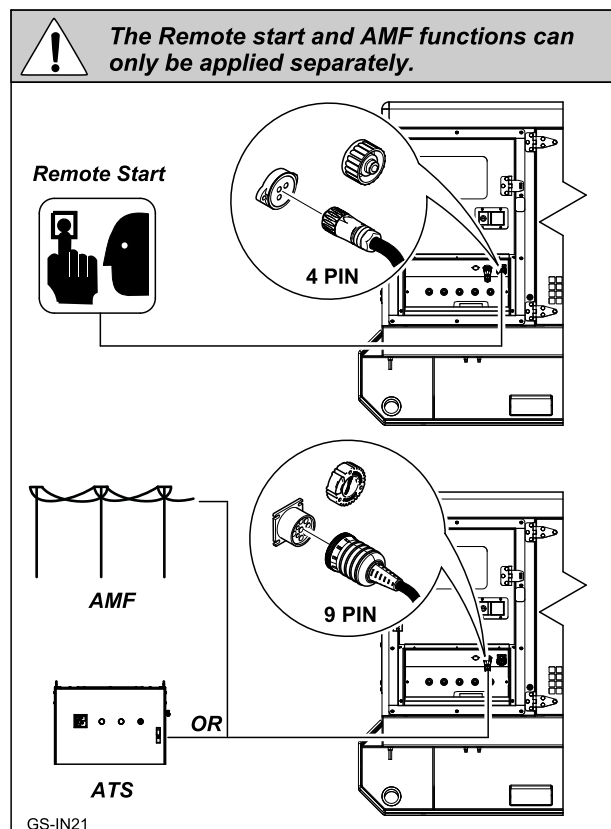

### 3.9.3 Mains Input Connections

Mains can provide power to critical components on the generator set, like battery charger, coolant heater, oil heater and other devices.

The standard product is equipped with battery charger which is located in the electric components box. The power of battery decreases while the battery is stored or not running for a long time. To maintain the generator set in a good capability of starting, recharge it once a month in summer, and every 2 months in winter. The user can charge the battery by connecting the connector (4 or 9 pin which are mentioned in **3.9.2 Remote start and AMF/ATS Communication Connections**) to the mains. The charge indicator in the control panel will illuminate when charging and be off after finishing the charge.





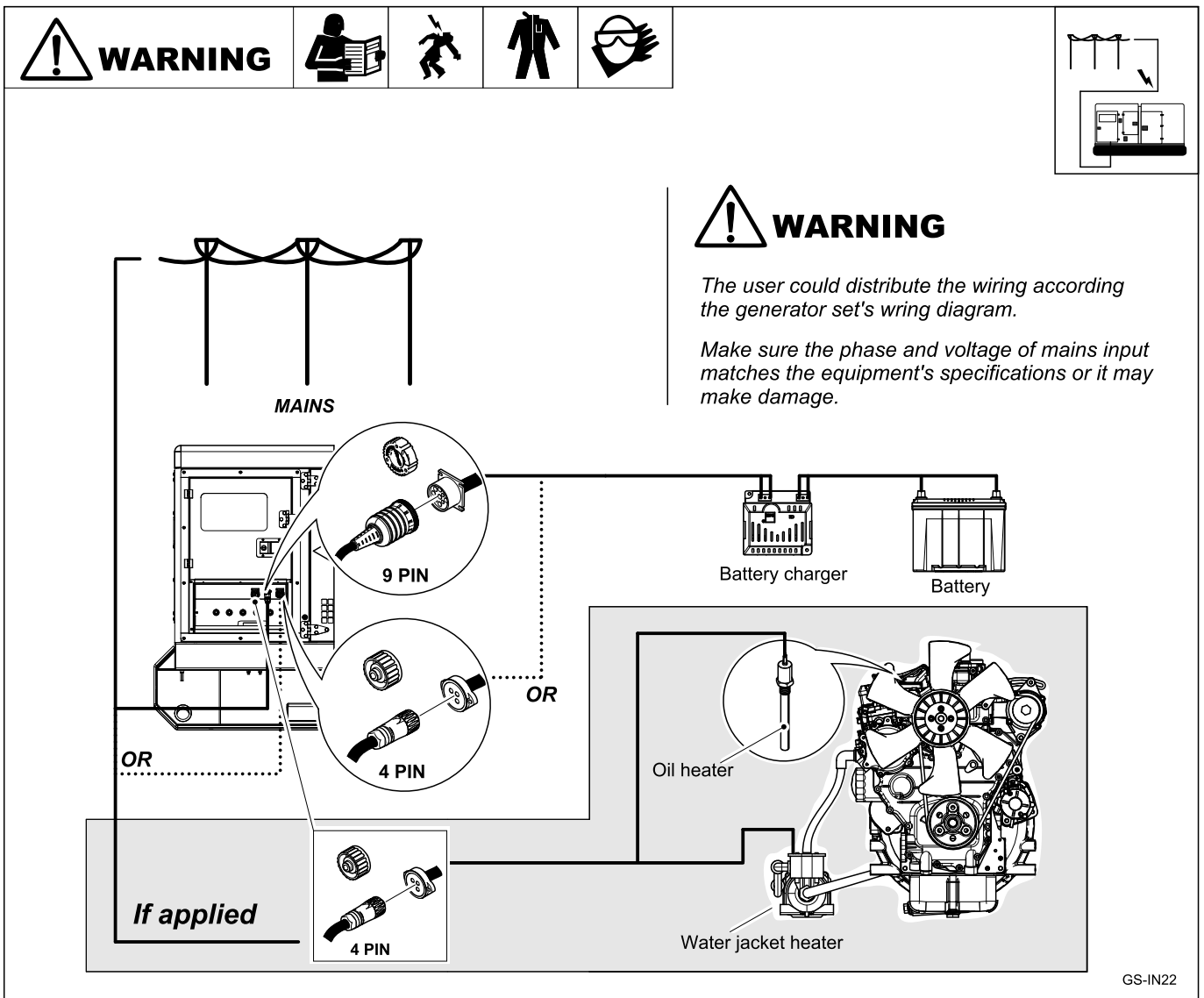



It is recommended to equip appropriate heater (water jacket heater, oil heater or other devices) on the engine for it is hard to start in the cold environment. The heater starts to work automatically when it powered by the mains. When the temperature reaches the preset value or the engine has started, the heater unit will stop working automatically.

The standard product provides an additional mount hole (be blocked by a plug if not be applied) for the heaters connection which near the 4 or 9 pin connector. If the heater(s) is(are) opted, a 4 pin connector would be mounted. The user can activate the heating function by connecting the connector to the mains.

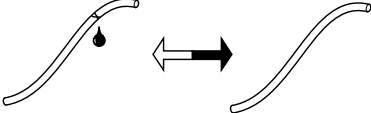
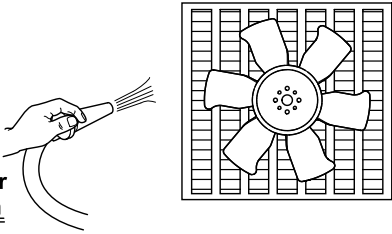
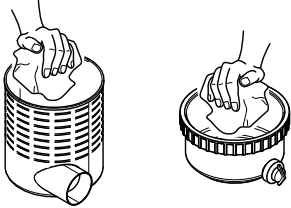
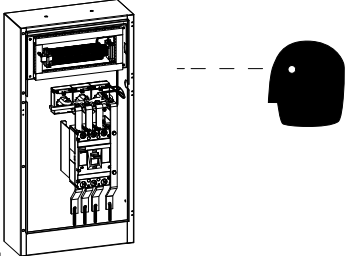
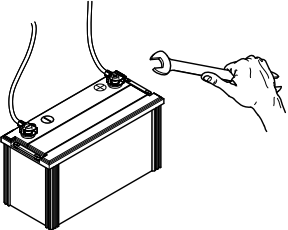
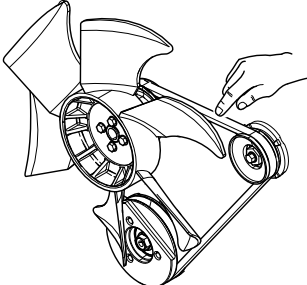

## 4 Pre-check Before Starting

### 4.1 General Pre-check

					 <p style="text-align: center; font-size: small;">PRE-CHECK</p>					
<p><b>Before starting the genset, check each item below to make sure that the machine can be started up properly and reduce any possible problems.</b></p>										
 <p><b>Hoses</b></p>	<ul style="list-style-type: none"> <li>• Check engine oil, fuel and coolant for leaks at the hose connections.</li> <li>• Check and make sure no debris has lodged in vents near radiator or around fan.</li> <li>• Check and make sure that nothing is touching the air cleaner, muffler or exhaust pipes.</li> <li>• Check all connections of electrical components inside the control cabinet and distribution cabinet, make sure none of them is broken or loose. All switches and circuit breakers should be set to the "OFF" position.</li> <li>• Check the battery, make sure that all bolts have been tightened.</li> <li>• Check the fan belt, make sure that it is tight.</li> <li>• Check the load connection, make sure that it is in accord with the requirements.</li> <li>• Check the genset's fixation and installation, make sure that they are in accord with the requirements and would not bring bad impact or pollution to the environment.</li> <li>• Refer to Chapter 1 for Safety Instructions and follow them.</li> </ul>									
 <p><b>Radiator and Fan</b></p>										
 <p><b>Air Cleaner</b></p>										
 <p><b>Control Cabinet</b></p>										
 <p><b>Battery</b></p>										
 <p><b>Fan and Belt</b></p>										
<div style="display: flex; align-items: center;">  <div> <p><b>WARNING</b></p> <ul style="list-style-type: none"> <li>• Do not use the machine if any leak is found. Repair it first. Tighten or change the connection hose if necessary.</li> <li>• Failure to follow the procedures listed above may cause injury to personnel or damage to the genset. Be certain that all persons setting up the genset are certified or fully trained on the installation of the genset.</li> <li>• Always wear protective gloves and clothes during operation.</li> </ul> </div> </div>										

GS-MT1

## 4.2 Checking Engine Oil Level

### 4.2.1 Checking oil level

- 1) Make sure the engine is level.
- 2) Take out oil gauge and wipe it with a clean cloth.
- 3) Fully reinsert the oil gauge.
- 4) Take out the oil gauge. The oil level should be between the upper limit and lower limit.

### 4.2.2 Manual adding engine oil

- 1) Make sure the engine is level.
- 2) Remove the oil cap.
- 3) Add indicated amount of engine oil at the top or side engine oil inlet.
- 4) Wait three minutes and check oil level.
- 5) Add more oil if necessary.
- 6) Reinstall the oil cap and tighten it.



**WARNING**



GS-MT3

- A single or multigrade oil must be used which conforms to API or ACEA. Select the oil viscosity based on ambient temperature, see the chart below for details.
- If the machine is not level when checking the engine oil, you cannot obtain accurate oil level.
- Do not overfill the engine oil. The level cannot exceed the upper limit because the excessive amount of engine oil may damage the engine.
- Do not smoke or make naked flame near the machine when filling the engine oil.
- Do not leave oil anywhere for environmental protection. Wipe off oil residue on the engine or around after adding.

**WARNING**

OIL CHECKING

-30		-20		-10		0		10		20		30		40		50°C			
-22		-4		14		32		50		68		86		104		122°F			
0W				5W20				10W30				15W40				20W50			
				20				30				40							

Corresponding chart of engine oil viscosity and ambient temperature

GS-MT2

4.2.3 Auto adding engine oil

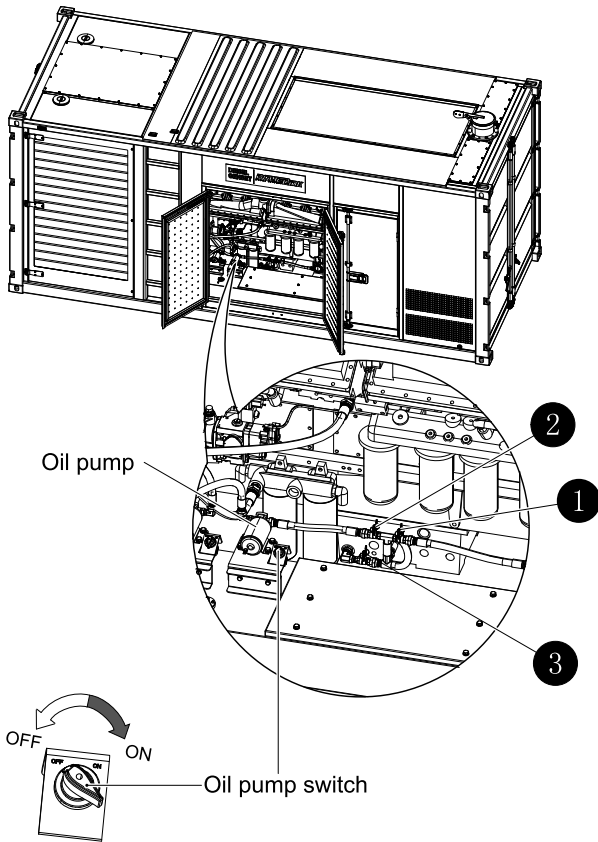
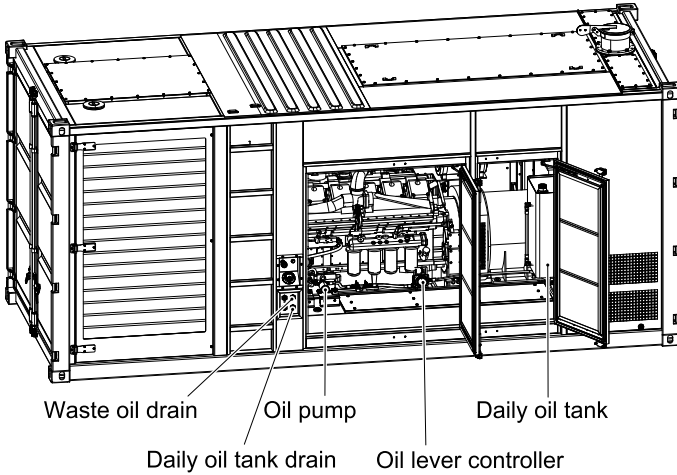

**1. Checking Oil Level**

Before the genset running, please check the engine oil lever from oil lever controller and the capacity of daily oil tank . If the oil capacity is not enough, please adding oil for engine. Please change it when found the oil performance is lower.

**2. Adding Engine Oil**

- 1) Open the ball valve ❶, ❸;
- 2) Close the ball valve ❷;
- 3) The oil lever controller will working auto, which adding oil from daily oil tank to engine.

**3. Change Engine Oil**

- 1) Open the ball valve ❷, ❸;
- 2) Close the ball valve ❶;
- 3) Turn the oil pump switch to "ON", and the oil pump will start working, the waste oil which in oil pan will drain out from Waste oil drain.
- 4) Adding new oil for engine according to the step of adding engine oil.



- Do not smoke or make naked flame near the genset when filling the oil.
- Take a plastic sheet and a container under the oil drain outlet to protect environment. Disposal of the waste liquid should be in accordance with the local environmental protection legislation

4.3 Checking Fuel Level(Manual fuel adding system)



**WARNING**



FUEL CHECKING

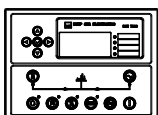

Control Module



Fuel level gauge (if applied)

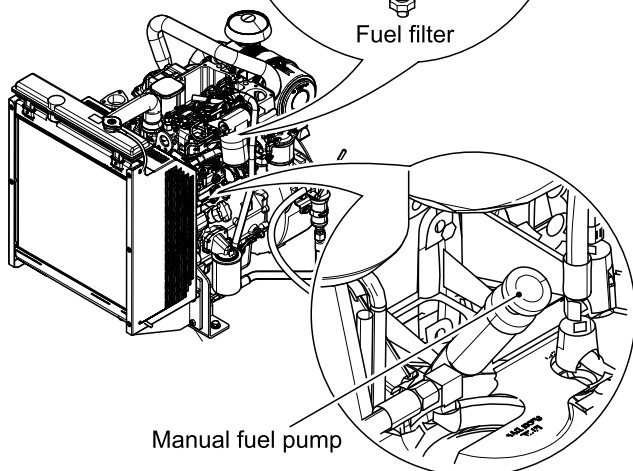
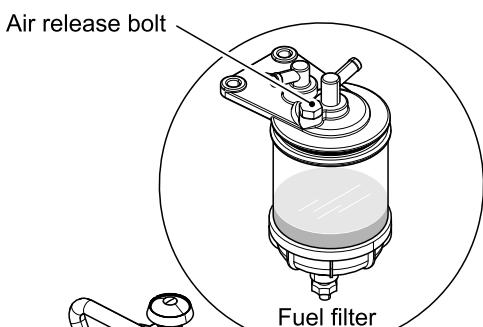
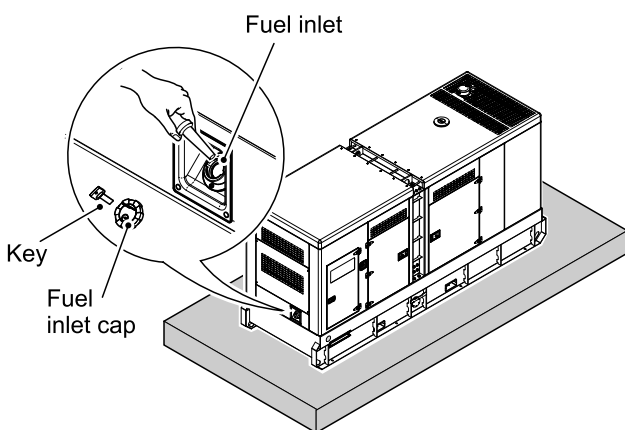

**CAUTION**



**1. Checking Fuel Level**

- 1) Make sure the fuel tank is level.
- 2) Check LCD of the control module or the fuel level gauge (if applied), add fuel if the reading is less than 50%.

**2. Manual fuel adding**

- 1) Make sure the fuel tank is level.
- 2) Clean the area around the fuel cap.
- 3) Remove the fuel cap from the fuel tank.
- 4) Fill the fuel until the fuel is slightly less than the full tank level by observing the fuel level gauge or LCD of the control module. NEVER overfill the fuel tank.
- 5) Replace the fuel cap, hand tighten. Over tightening the fuel cap will damage it.

**3. Extracting Air**

After adding fuel, the operator should extract the air in fuel system. Usually there is an air release bolt on the fuel filter, loosen the bolt to release air.

- 1) Loosen air release bolt on the fuel filter.
- 2) Press the manual fuel pump located in the fuel inlet pipe until the fuel drained from the air extract hole without bleb to extract the air in the fuel system.
- 3) Tighten the bolt.

• Refer to the Engine operation manual for details of engine fuel system's air extracting.



**WARNING**



- If the genset is not level when checking the fuel, you cannot obtain accurate fuel level.
- Do not smoke or make naked flame near the genset when filling the fuel.
- Do not leave fuel anywhere for environmental protection. Wipe off fuel residue on the fuel tank or around after adding.

4.4 Checking Fuel Level(Auto fuel adding system)

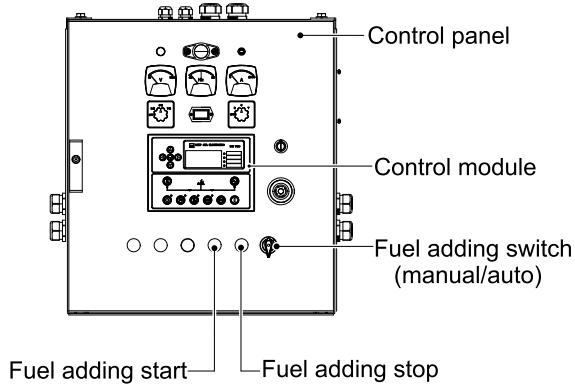

1. Checking Fuel Level

- 1) Make sure the fuel tank is level.
- 2) Check LCD of the control module or the fuel level gauge (if applied), add fuel if the reading is less than 50%.

2. Manual fuel adding

- 1) Turn the fuel pump switch to "ON".
- 2) Turn the fuel adding switch to "manual".
- 3) Press the fuel adding start button and start adding fuel to fuel tank.
- 4) Press the fuel adding stop button when the fuel is slightly less than the full tank level observing the fuel level gauge or LCD of the control module. NEVER overfill the fuel tank..

3. Auto fuel adding

- 1) Turn the fuel pump switch to "ON".
- 2) Turn the fuel adding switch to "auto".
- 3) If there is a lack of fuel, control module will give a signal to start the fuel pump, and the genset begin to add fuel.
- 4) When the fuel is slightly less than the full tank level observing the fuel level gauge or LCD of the control module. The module will give a signal to stop adding fuel.

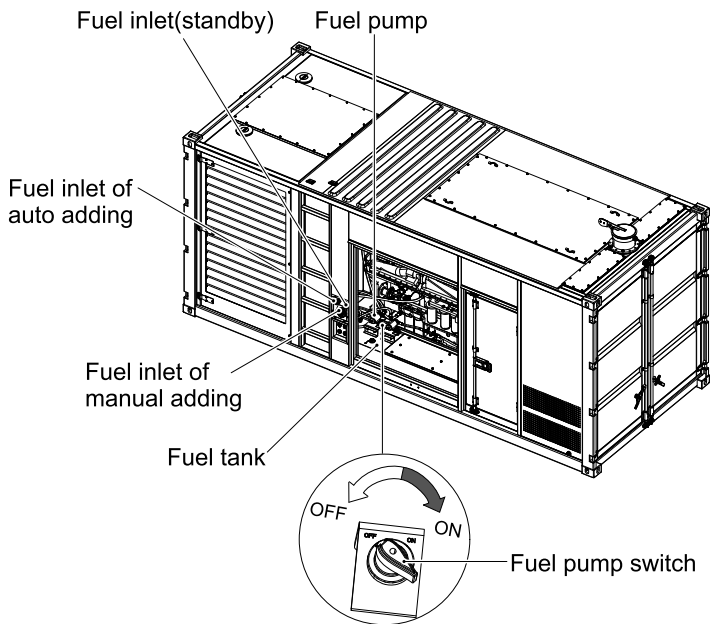

- Make sure the external fuel tank and genset are mounted on the same level.
- Make sure the external fuel tank has been grounded for the fuel is flammable and explosive.
- DO NOT route hose above external fuel tank connection, or loop or kink hoses. This will cause air locks in the hose and block circulation of the fuel.

4.5 Checking Coolant Level

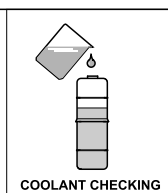
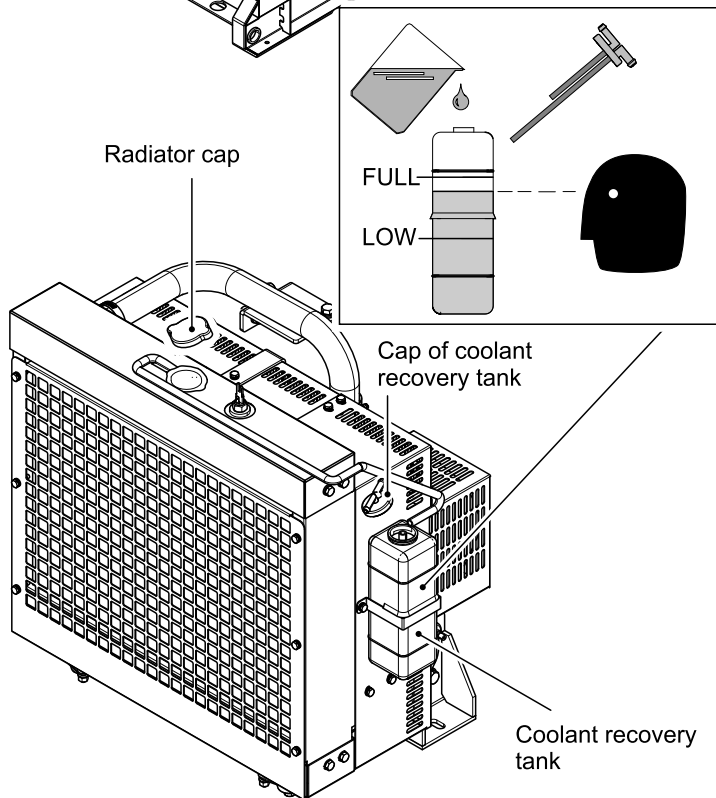
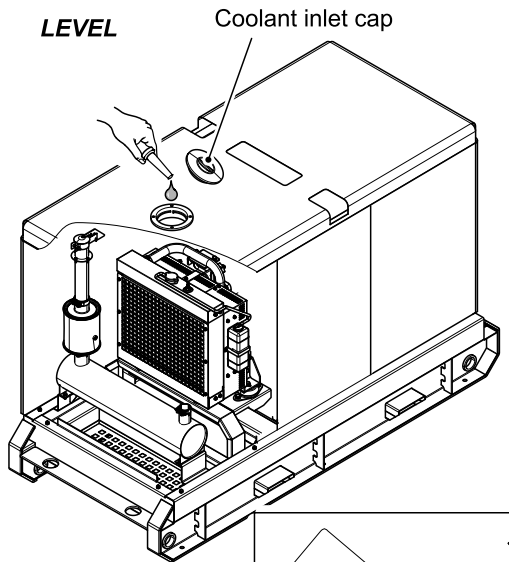
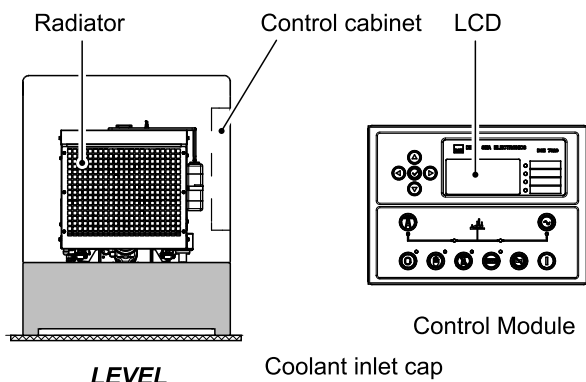

**CAUTION**

**1. Checking Coolant Level**

- 1) Make sure the radiator is level.
- 2) Check the coolant level in the radiator and add coolant if the level is under the lower mark. Or check the LCD of the control module and add coolant if its reading is lower than 80%.

**2. Adding Coolant**

- 1) Check to be sure the radiator drain valve is installed and tightened.
- 2) Remove the coolant cap on the top of the canopy.
- 3) Loosen the radiator cap slowly to extract the pressure steam. Then remove the radiator cap by turning it counterclockwise about 1/3 of a turn.
- 4) Pour the engine coolant slowly into the radiator until the level is slightly lower than the lip of the engine coolant filler port. Make sure that air bubbles do not develop as you fill the radiator.
- 5) Reinstall the radiator cap. Align the tabs on the back side of the radiator cap with the notches on the engine coolant filler port. Press down and turn the cap clockwise about 1/3 of a turn.
- 6) Remove the cap of the coolant recovery tank and fill it to the LOW mark with engine coolant. Reinstall the cap.
- 7) Check the hose that connects the coolant recovery tank to the radiator. Be sure it is securely connected and there are no cracks or damage. If the hose is damaged, engine coolant will leak out instead of going into the coolant recovery tank.
- 8) Reinstall the coolant cap on the roof of canopy.

**WARNING**



- Select the proper coolant. Recommend using a mixture of ethylene glycol antifreeze & water as a coolant.
- If the radiator is not level when checking the coolant, you cannot obtain accurate coolant level.
- Do not open the radiator cap while operating the genset or just immediately after stopping the machine, because that may cause burns from hot vapour or coolant.
- Wait until the engine cools before you drain the engine coolant. Hot engine coolant may splash and burn you.
- Do not leave coolant anywhere for environmental protection. Wipe off coolant residue on the radiator or around after adding.

GS-MT5

4.6 Checking Battery Coulomb



**WARNING**

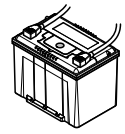

BATTERY CHECKING

Check the color inside the magic eye

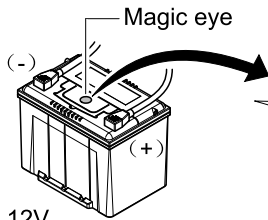

12V

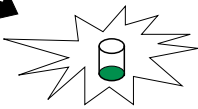

Green: Coulomb is sufficient

**NOTICE:**

- ❶ Black: Coulomb is insufficient. Charge it please.
- ❷ White: The battery is damaged. Replace it please.

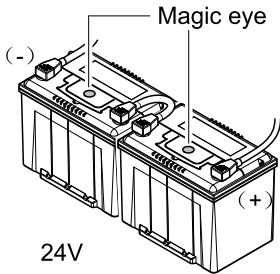

24V

Measure the battery's voltage

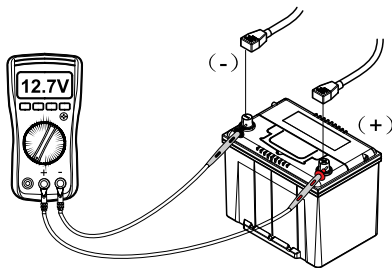

Charge the battery

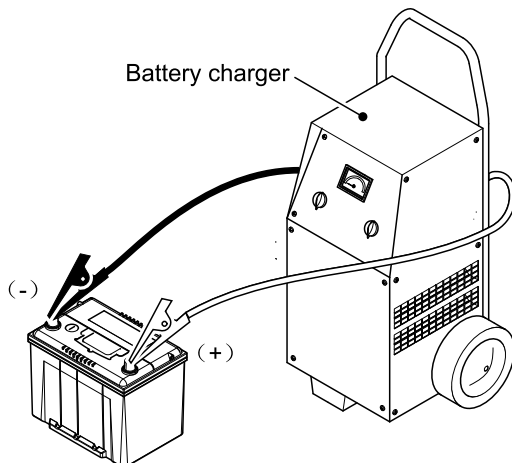

**CAUTION**



**1. Check the battery's coulomb**

Two ways are as below:

1) Check the color inside the magic eye (it is on the top surface of the battery):

- Green: The coulomb is sufficient. You can use the battery now.
- Black: The coulomb is insufficient. You should charge the battery, then use it.
- White: The battery is damaged. You must replace it

**NOTICE:**

If it is white inside the magic eye, shake the battery slightly several times, then check the color. The coulomb is sufficient if the color turns to green.

2) Measure the battery's voltage:

Disconnect the cables on the positive and negative terminals, and use a volometer or multimeter to measure the voltage of the battery.

Battery Voltage		
Season	Sufficient Coulomb	Insufficient Coulomb (Need to charge)
Summer	> 12.4V	≤12.4V
Winter	> 12.6V	≤12.6V

**2. Charge the battery**

Charge the battery with a special charger if the coulomb is insufficient.

- 1) Uninstall the battery from the machine.
- 2) Battery charging.
- 3) Install the battery to the machine after charging.







**CAUTION**

- The engine could not start if the battery's coulomb is insufficient. Charge the battery in time please.
- Read and follow all instructions supplied with battery charger.

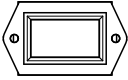
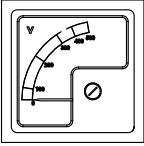
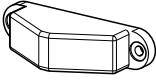
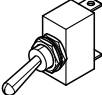
## 5 Operation For PLC-920 Control System

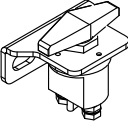
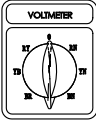
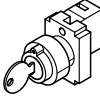
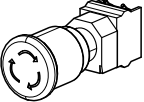
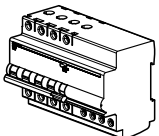
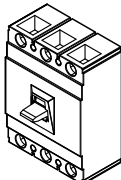
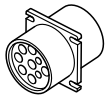
### 5.1 Main Electrical Components

Meter		1000233070-IT3-A2	
			
Time counter		Voltage meter	
Indicator and Switch			
			
Control cabinet lamp	Alarm indicator	Charge indicator	Battery isolator
			
		Voltmeter change-over switch	Ammeter change-over switch
Button, Circuit Breaker and Communication Interface			
			
Emergency stop button	Main circuit breaker (minitype)	Main circuit breaker	Communication connector (9 pin)
			
		Communication connector (4 pin)	
Functional Description			
Time counter	Display genset runtime.	Emergency stop button	Used to stop the machine under emergent condition. The engine stops at once after pressing the button.
Voltage meter	Display the line voltage value between different phases.	Main circuit breaker	It controls the genset's main circuit. It has two positions: "ON" and "OFF". When the current in the main circuit is above its rated value, it will turn to the "OFF" position automatically and interrupt the main circuit.
Control cabinet lamp	Used to light the control cabinet.		
Control cabinet lamp switch	It controls the control cabinet lamp on/off. When it is turned to "ON", the lamp lights	9 pin communication connector	Used for remote control and realize remote start/stop function. It also can be used to input mains and charge the battery.
Charge indicator	It illuminates when the battery is charged by the mains supply.	4 pin communication connector	Used for remote control and realize remote start/stop function. It also can be used to input mains and charge the battery.
Battery isolator	Mounted on the side of the engine. It controls the battery on/off.		
Voltmeter change-over switch	By operating the switch the voltage meter displays the line voltage value between corresponding phases.		
Key switch	It controls the power on/off. When turning it to "ON", the control module is powered. Then you can operate the control panel.		

5.2 Control Module and Protection Function



**WARNING**

GS-OP2

- Refer to troubleshooting guidelines in this manual to repair the machine and remove the fault. Contact **POWERLINK** or our authorized distributor for help if you could not deal with it.
- Press the emergency stop button if an emergency or serious fault occurs and the genset will be stopped immediately.

**Control Module** 1000233070-IT4-A2

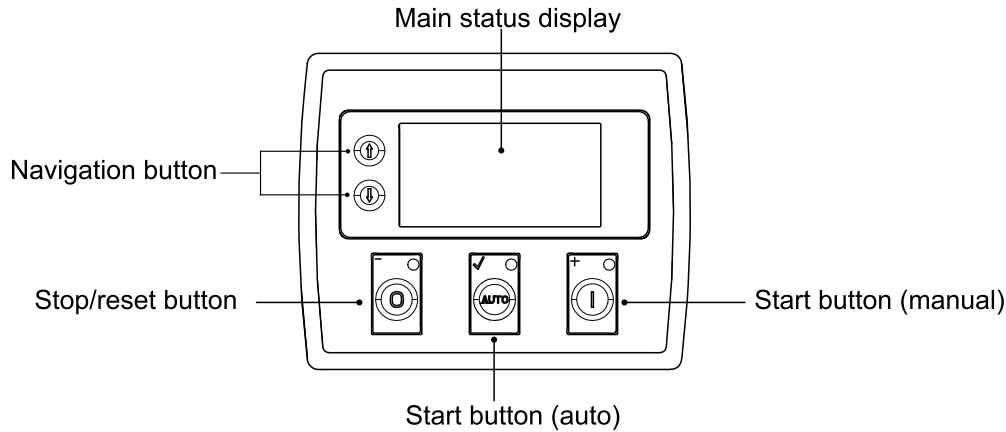

**Button Icon Description**

- This button is used for showing previous /next page in normal operation. In Programming mode it is used for showing previous /next parameters on the currently selected page.
- This button is used for showing previous /next parameters on the currently selected page.
- The RESET button will reset the controller after a failure has been detected. The STOP button is used for changing operating mode of the unit to the Stop Mode. The generator is stopped. In Programming mode, it operates as an Down button (changing cursor position) or Decrement button (decrease parameter value).
- The AUTO button is used for changing operating mode of the unit to the Auto Mode. In Programming mode, it is used for entering parameter edit section, saving parameter value.
- The START button is used for starting the engine when the unit is in the Manual Mode. In Programming mode, it operates as an Up button (changing cursor position) or Increment button (increase parameter value).

**Protection Function**



<b>Warn</b>	Corresponding alarm LED illuminates when any warning affair occurs. Warning is non-critical and do not affect the operation, they serve to draw the user's attention to an undesirable condition. The user may deal with it at once or after working.
<b>Shut down</b>	Genset is equipped with automatic shutdown feature. When the control module monitors any shutdown information, corresponding alarm LED flashes. and the engine stops at once. The user must remove the fault before restarting.

No.	Abnormality	Warning	Shutdown
1	High engine temperature	•	•
2	Low oil pressure	•	•
3	Over speed	•	•
4	Battery charge failure	•	
5	Stop failure	•	
6	Start failure		•

### 5.3 Operation Instruction



- Before switching on the Main Circuit Breaker, make sure all circuit breakers and switches of loads are shut off. Otherwise, it may cause an electric shock to the operator.
- During operation the control system would alarm if the genset fails to start, or output voltage and frequency are not accord with the preset values. Do not close any load before restarting or removing faults.
- Turn off all switches of loads before stopping. Otherwise, it might cause damages to the genset and themselves.

#### 5.3.1 Manual Operation

##### (1) Start

- 1) Shut off every switch and circuit breaker of loads.
- 2) Shut off the **Genset Main Circuit Breaker (GB)** and other circuit breakers.
- 3) Turn the **Battery Isolator** to "ON".
- 4) Turn the **Key Switch** to "ON".
- 5) Press the **Manual Start Button**, then the fuel solenoid is energised, and after delay time the starter motor begins to run and make the engine crank.
- 6) After the engine starts successfully, keep it idling for about 5 minutes to let it warm up. When the genset runs normally, check the reading of **Voltage Meter** by operating the **Voltmeter Change-Over Switch**. If they are in accord with the preset values, switch on the **Genset Main Circuit Breaker**.
- 7) Switch on every switch or circuit breaker of loads (**from heavy to low** in sequence), export power to load.

##### (2) Stop

- 1) Shut off all switches and circuit breakers of loads (**from low to heavy** in sequence).
- 2) Shut off the **Genset Main Circuit Breaker** and other circuit breakers.
- 3) Press the **Stop Button**.
- 4) The engine will idle for about 1 minute to cool down. Then it stops.
- 5) Turn the **Key Switch** to "OFF".
- 6) Turn the **Battery Isolator** to "OFF".

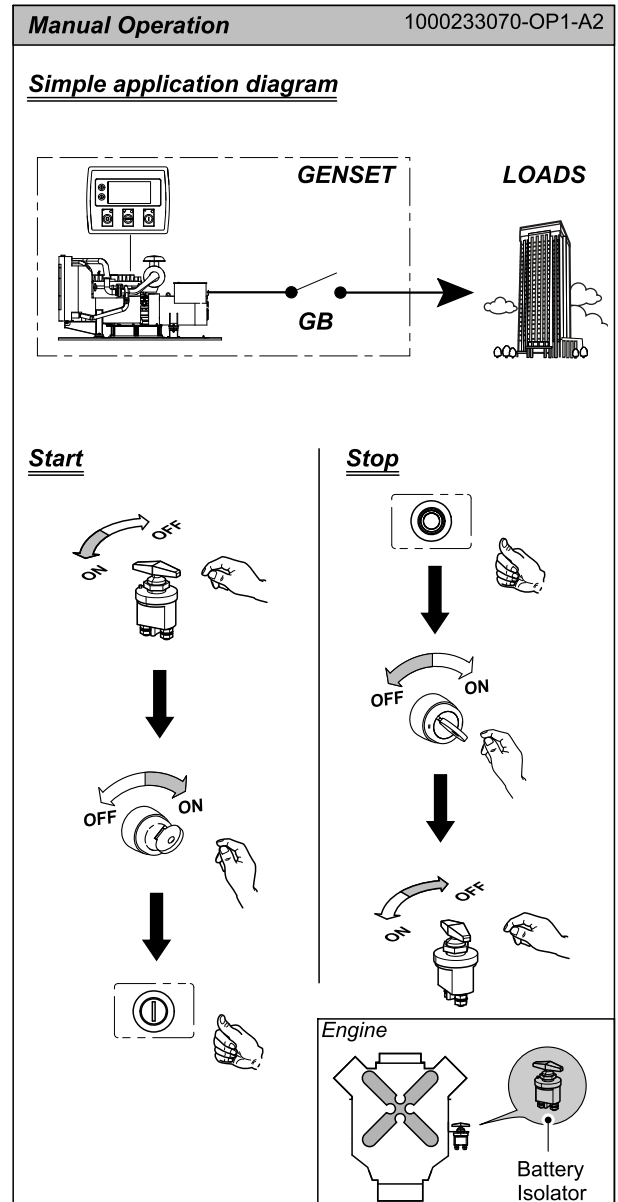

5.3.2 Remote Operation

Remote Operation

The genset can be set remote control function. Connecting to the remote control switch by 9 or 4 pin communication connector realizes remote start and stop.

• Setting remote control switch

- 1) Connect the remote communication line (if applied) to the communication connector on the genset.
- 2) Make a remote start switch through connecting the corresponding terminals in the other end of communication line with suitable wirings. The user can distribute the wiring according to the genset wiring diagram.

• Adjusting the genset to remote control mode

- 1) Turn the **Battery Isolator** to "ON".
- 2) Turn the **Key Switch** to "ON".
- 3) Press **Auto Mode Button**. Its LED illuminates.
- 4) Switch on the **Genset Main Circuit Breaker (GB)**.

• Operation Instruction

(1) Start

- 1) Press the **Remote Start Button**.
- 2) When the control module receives remote start signal, it will perform the auto start sequence.
- 3) After the genset starts successfully, switch on every switch of loads (**from heavy to low** in sequence). The genset will export power to load.

(2) Stop

- 1) Shut off all switches and circuit breakers of loads (**from low to heavy** in sequence).
- 2) Press the **Remote Stop Button**.
- 3) The engine keeps idling until cooling time is over. Then it stops.

In addition, connecting 9 pin connector to ATS control cabinet can realize to transfer automatically the power supply of loads between the mains and genset. Refer to "ATS Control Cabinet Operation Manual" for details.

Remote Operation

1000233070-OP3-A2

Simple application diagram

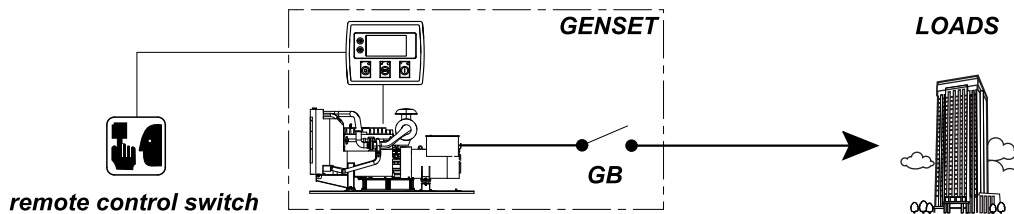

Adjusting the genset to remote control mode

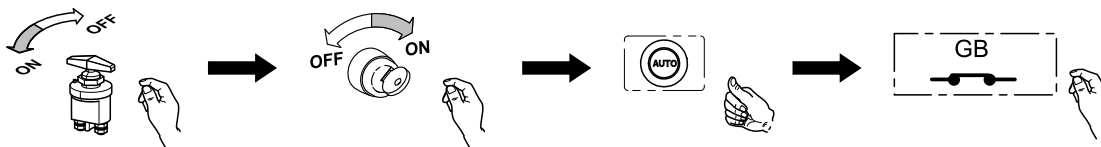

Start

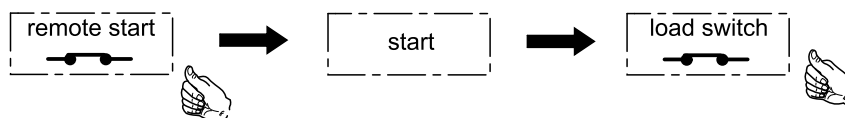



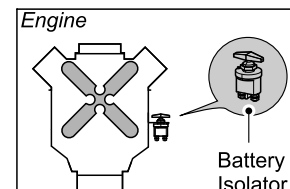
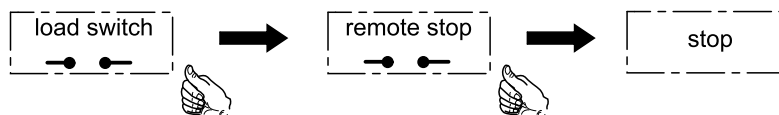



Stop



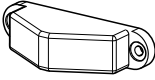

## 6 Operation For PLC-7420 Control System

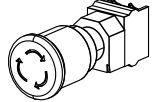
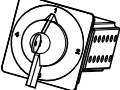
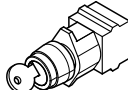
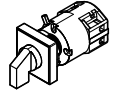
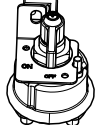
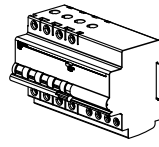
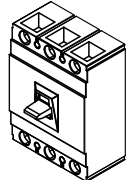
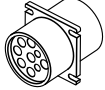
### 6.1 Main Electrical Components

Indicator and Button		1000061877-IT1-C3	
			
	Control cabinet lamp	Voltage adjust knob	Charge indicator
Frequency adjust knob	Emergency stop button		
Switch			
			
Frequency/voltage changeover switch	Key switch	Control cabinet lamp switch	Battery isolator
Circuit Breaker and Communication Interface			
			
Main circuit breaker (minitype)	Main circuit breaker	Communication connector (9 pin)	Communication connector (4 pin)
Functional Description			
Control cabinet lamp	Used to light the control cabinet.	Control cabinet lamp switch	It controls the control cabinet lamp on/off. When it is turned to "ON", the lamp lights
Voltage adjust knob	Used to trim the voltage value after operating frequency or voltage changeover.	Battery isolator	Mounted on the side of the engine. It controls the battery on/off.
Charge indicator	It illuminates when the battery is charged by the mains supply.	Main circuit breaker	It controls the genset's main circuit. It has two positions: "ON" and "OFF". When the current in the main circuit is above its rated value, it will turn to the "OFF" position automatically and interrupt the main circuit.
Frequency adjust knob	Used to trim the frequency value after operating frequency or voltage changeover.		
Emergency stop button	Used to stop the machine under emergent condition. The engine stops at once after pressing the button.	9 pin communication connector	Used to connect the mains or ATS cabinet, and realize the AMF function or remote control. It also can be used to charge the battery.
Frequency /voltage changeover switch	Used to transfer output frequency/voltage to 60Hz/220V, 60Hz/440V, 50Hz/200V or 50Hz/400V, The switch only can be operated when the machine is in stop condition.	4 pin communication connector	Used for remote control of genset and realize remote start/stop function. It also can be used to charge the battery.
Key switch	It controls the power on/off. When turning it to "ON", the control module is powered. Then you can operate the control panel.		

6.2 Control Module

Control Panel	1000061877-IT2-B2
<p>The diagram shows a control panel with an LCD display at the top center. To the left of the display are four directional buttons (up, down, left, right) and an 'Accept' button. Below these are buttons for 'Increase value / previous item', 'Next page', 'Decrease value / next item', 'Previous page', and 'Transfer to mains'. To the right of the display are four alarm LEDs. Below the LEDs are buttons for 'Transfer to genset', 'Mains available LED', 'Genset available LED', 'Stop / reset (with LED)', 'Manual start', 'Manual mode (with LED)', 'Mute alarm / lamp test', 'Close mains LED', 'Close genset LED', 'Test mode (with LED)', and 'Auto mode (with LED)'.</p>	
Button Icon Description	
	<p><b>Stop / Reset:</b> This button places the module into its Stop/Reset mode. This will clear any alarm conditions for which the triggering criteria have been removed. If the engine is running and the module is in stop mode, the module will automatically instruct the changeover device to unload the genset. The fuel supply de-energises and the engine comes to a standstill. Should a remote start signal be present while operating in this mode, a remote start will not occur.</p>
	<p><b>Manual mode:</b> This mode allows manual control of the genset functions. Once in Manual mode the module will respond to the manual start button, start the engine, and run off load.</p>
	<p><b>Auto mode:</b> This button places the module into its 'automatic' mode. This mode allows the module to control the function of the genset automatically. The module will monitor the remote start input and mains supply status and once a start request is made, the genset will be automatically started and placed on load. Upon removal of the starting signal, the module will automatically transfer the load from the genset and shut the unit down observing the stop delay timer and cooling timer as necessary. The module will then await the next start event.</p>
	<p><b>Test mode:</b> This button places the module into its 'test' mode. And it allows an on load test of the genset. Once in test mode the module will respond to the manual start button, start the engine, and run on load.</p>
	<p><b>Manual start:</b> This button is only active in stop/reset or manual mode. Pressing this button in manual or test mode will start the engine and run off load (manual) or on load (test). Pressing this button in stop/reset mode will turn on the CAN engine ECU (when correctly configured and fitted to a compatible engine ECU).</p>
	<p><b>Mute alarm / lamp test:</b> This button silences the audible alarm if it is sounding and illuminates all of the LEDs as a lamp test feature. When correctly configured and fitted to a compatible engine ECU, pressing this button in stop/reset mode after pressing the manual start button (to power the ECU) will cancel any "passive" alarms on the engine ECU.</p>
	<p><b>Transfer to mains:</b> When in manual mode only, pressing the button allows the operator to transfer the load to the mains (note: the machine has not set the feature).</p>
	<p><b>Transfer to genset:</b> When in manual mode only, pressing the button allows the operator to transfer the load to the genset (note: the machine has not set the feature).</p>
	<p><b>Menu navigation:</b> Including up, down, left, right direction button and accept button. Used for navigating the instrumentation, event log and configuration screens.</p>

6.3 Working State Chart

(1) Manual Operation State

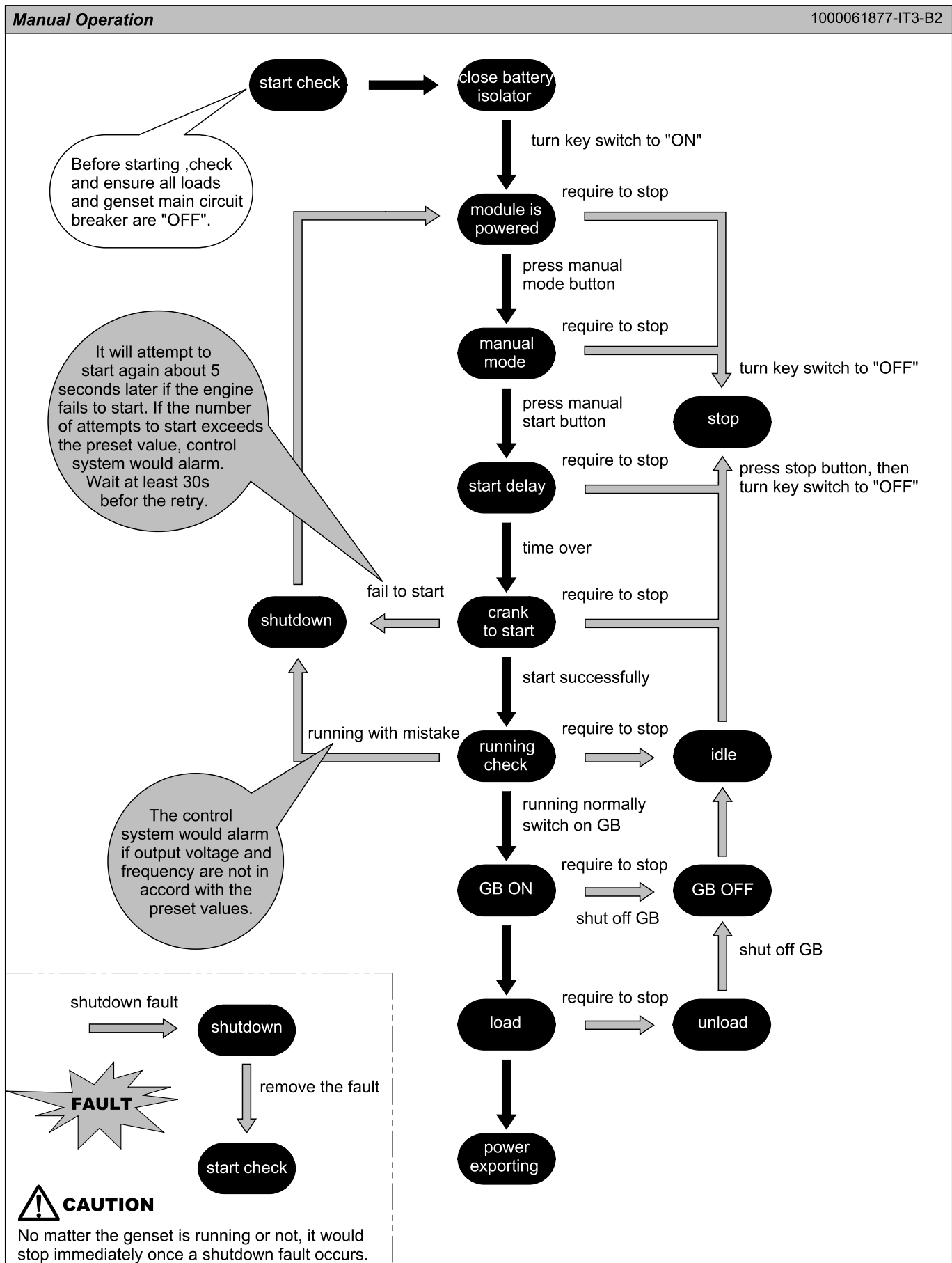



(3) AMF Operation Chart

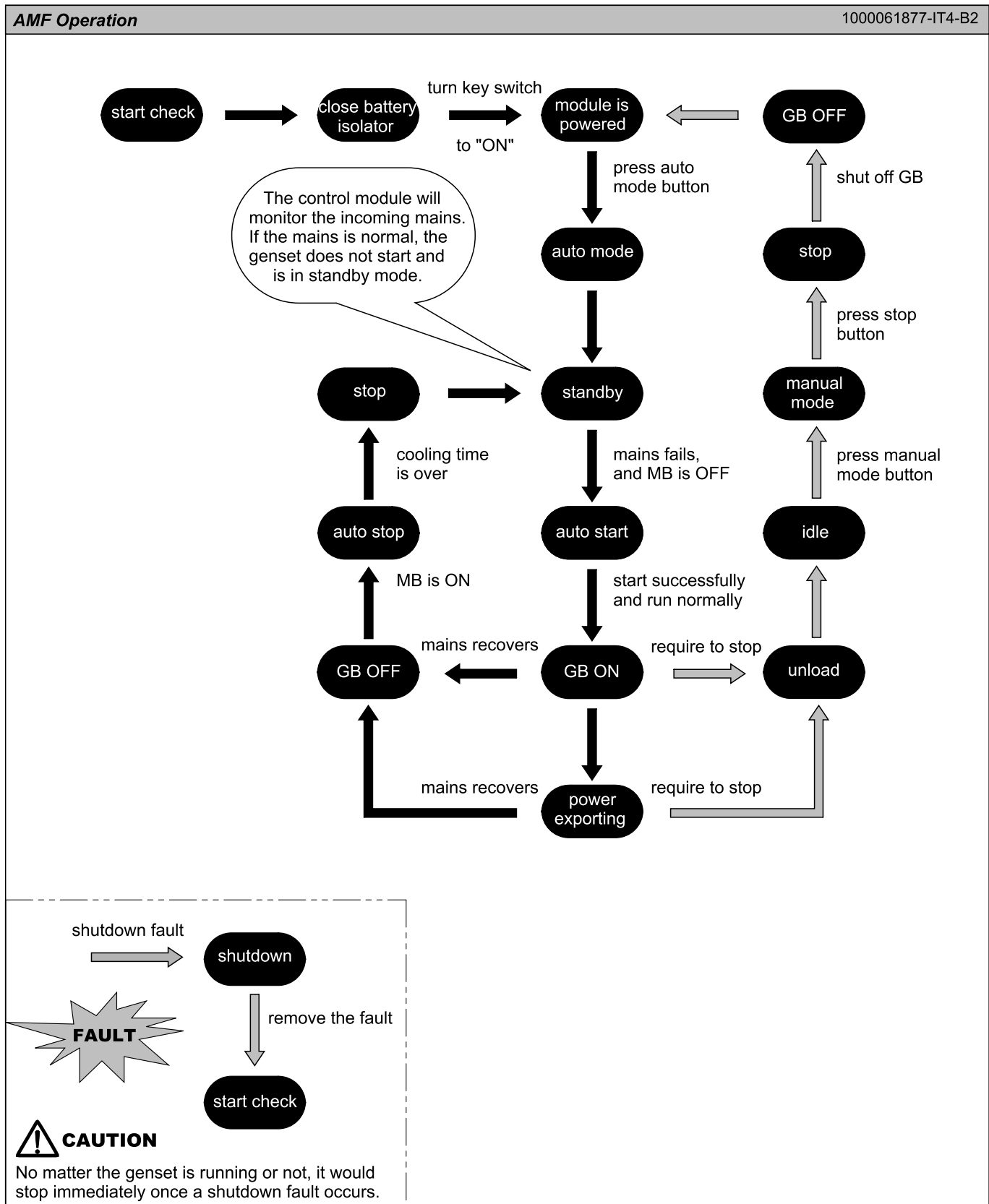

## 6.4 Operation Instruction



- Before switching on the Main Circuit Breaker, make sure all circuit breakers and switches of loads are shut off. Otherwise, it may cause an electric shock to the operator.
- During operation the control system would alarm if the genset fails to start, or output voltage and frequency are not accord with the preset values. Do not close any load before restarting or removing faults.
- Turn off all switches of loads before stopping. Otherwise, it might cause damages to the genset and themselves.

### 6.4.1 Manual Operation

#### (1) Start

- 1) Shut off every switch and circuit breaker of loads.
- 2) Shut off the **Genset Main Circuit Breaker (GB)** and other circuit breakers.
- 3) Turn the **Battery Isolator** to "ON".
- 4) Turn the **Key Switch** to "ON".
- 5) Press the **Manual Mode Button**. Its LED illuminates.
- 6) Press the **Manual Start Button**, then the fuel solenoid is energised, and after delay time the starter motor begins to run and make the engine crank.
- 7) After the engine starts successfully, keep it idling for about 5 minutes to let it warm up. The control system checks automatically output voltage and frequency. If they are right, the **Genset Available LED** would illuminate. Then switch on the **Genset Main Circuit Breaker**, the **Close Genset LED** illuminates.
- 8) Switch on every switch or circuit breaker of loads (**from heavy to low** in sequence), export power to load.

#### (2) Stop

- 1) Shut off all switches and circuit breakers of loads (**from low to heavy** in sequence).
- 2) Shut off the **Genset Main Circuit Breaker** and other circuit breakers.
- 3) Press the **Stop Button**.
- 4) The engine will idle for about 1 minute to cool down. Then it stops.
- 5) Turn the **Key Switch** to "OFF".
- 6) Turn the **Battery Isolator** to "OFF".

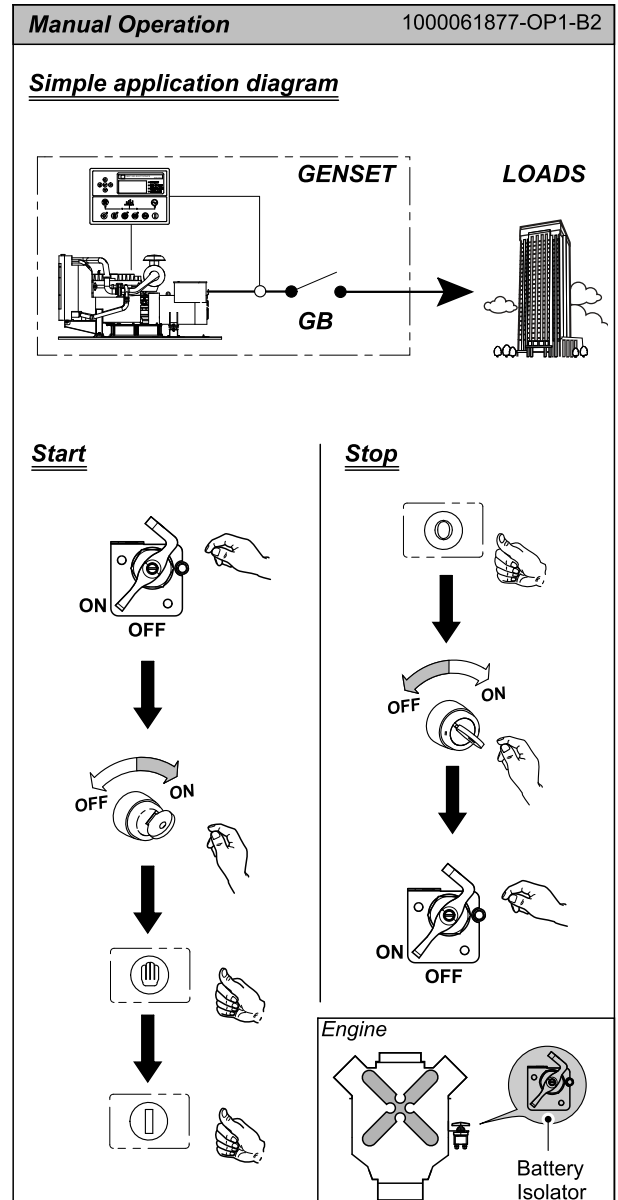

6.4.2 Remote Operation

The genset can be set remote control function. Connecting to the remote control switch by 9 or 4 pin communication connector realizes remote start and stop.

**NOTE:** Remote start and AMF functions can only be applied separately.

• **Setting remote control switch**

- 1) Connect the remote communication line (if applied) to the communication connector on the genset.
- 2) Make a remote start switch through connecting the corresponding terminals in the other end of communication line with suitable wirings. The user can distribute the wiring according to the genset wiring diagram.

• **Adjusting the genset to remote control mode**

- 1) Turn the **Battery Isolator** to "ON".
- 2) Turn the **Key Switch** to "ON".
- 3) Press **Auto Mode Button**. Its LED illuminates.
- 4) Switch on the **Genset Main Circuit Breaker**.

• **Operation Instruction**

**(1) Start**

- 1) Press the **Remote Start Button**.
- 2) When the control module receives remote start signal, it will perform the auto start sequence.
- 3) After the genset starts successfully, switch on every switch of loads (**from heavy to low** in sequence). The genset will export power to load.

**(2) Stop**

- 1) Shut off all switches and circuit breakers of loads (**from low to heavy** in sequence).
- 2) Press the **Remote Stop Button**.
- 3) The engine keeps idling until cooling time is over. Then it stops.

In addition, connecting 9 pin connector to ATS control cabinet can realize to transfer automatically the power supply of loads between the mains and genset. Refer to "ATS Control Cabinet Operation Manual" for details.

**Remote Operation**

1000061877-OP3-C-B2

Simple application diagram

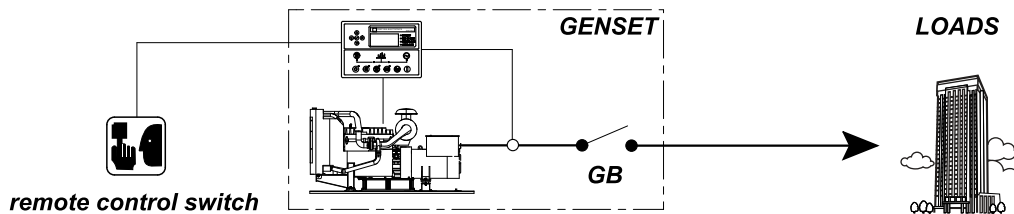

Adjusting the genset to remote control mode

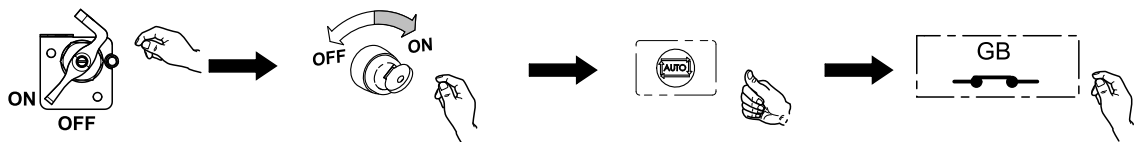

Start

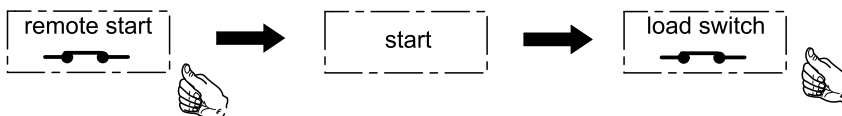

Stop

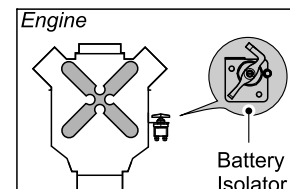
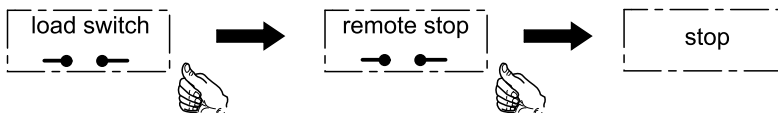

6.4.3 AMF Operation

PLC-7420/7320 control system has AMF function. It is able to realize to start and stop the genset automatically by connecting 9 pin communication connector to the mains, and transfer automatically the power supply of loads between the mains and genset by the control of genset's motor main circuit breaker (if applied). If in doubt, refer to local **Electrical Supply Company** for advice.

• **Setting communication between the genset and mains**

- 1) Connect the mains communication line (if applied) to the communication connector on the genset.
- 2) Connect the corresponding terminals in the other end of communication line to the mains (L1,L2,L3,N) with suitable wirings. The user can distribute the wiring according to the genset wiring diagram.

• **Adjusting the genset to AMF control mode**

- 1) Shut off **Genset Main Circuit Breaker (GB)**.
- 2) Turn the **Battery Isolator** to "ON".
- 3) Turn the **Key Switch** to "ON".
- 4) Press **Auto Mode Button**. Its LED illuminates.

- 5) The control module will monitor the mains. The genset does not start and is in standby mode if the mains is normal.

• **Operation Instruction**

**(1) Start**

- 1) If the mains becomes abnormal (e.g. over-voltage, under-voltage, over-frequency, under-frequency etc.), the **Mains Breaker (MB)** would be shut off automatically, and the control module would perform the auto start sequence.
- 2) If the genset starts successfully and runs at correct voltage and frequency, **GB** would be switched on automatically, and the unit exports power to load.

**(2) Stop**

- 1) If the mains recovers, the control module would perform stop sequence automatically.
- 2) After delay time, **GB** is shut off automatically and **MB** switched on.
- 3) The engine keeps idling until cooling time is over. Then it stops.

**NOTE:** If the user wants to stop manually the genset, first press the **Manual Mode Button** to make the genset be in manual mode, then press the **Stop Button**.

AMF Operation

1000061877-OP2-B2

Simple application diagram

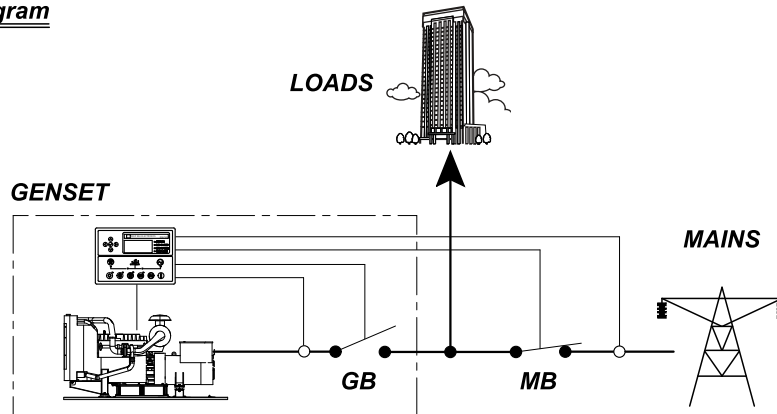

Adjusting the genset to AMF control mode

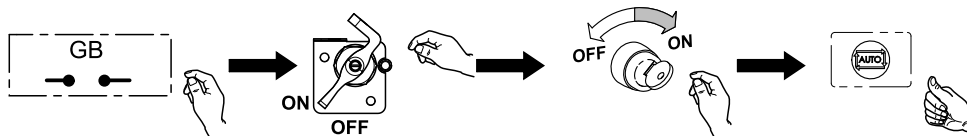

Start

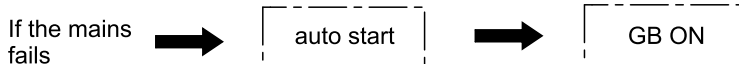

Stop

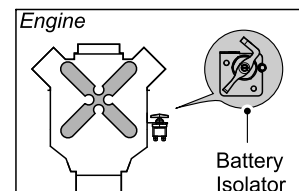
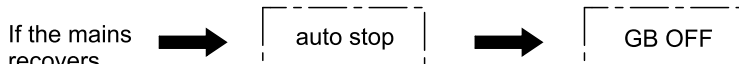

6.5 Protection Function



GS-OP2

- Refer to troubleshooting guidelines in this manual to repair the machine and remove the fault. Contact **POWERLINK** or our authorized distributor for help if you could not deal with it.
- Press the emergency stop button if an emergency or serious fault occurs and the genset will be stopped immediately.

**WARNING**

↓

<b>Alarm</b>	Alarm LED: The corresponding alarm LED (if configured) illuminates when an alarm is present.
	Sound: The audible alarm sounds when a warning or shutdown occurs. Pressing the Mute Alarm Button can silence the sound.
	LCD: The screen on the control module can display appropriate alarm text.

↓

<b>Warn</b>	LCD displays the warning alarm information and the alarm LED illuminates when any warning affair occurs. Warning is non-critical and do not affect the operation, they serve to draw the user's attention to an undesirable condition. The user may deal with it at once or after working for some time.
	<b>Shut down</b>

No.	Abnormality	Warning	Shutdown
1	High engine temperature	•	•
2	Low oil pressure	•	•
3	Over speed	•	•
4	Low speed	•	•
5	High frequency	•	•
6	Low frequency	•	•
7	High voltage	•	•
8	Low voltage	•	•
9	High current	•	•
10	Low fuel level	•	
11	Start failure		•
12	Stop failure	•	
13	Battery charge failure	•	
14	High battery voltage	•	
15	Low battery voltage	•	
16	Oil pressure sensor open circuit		•
17	No speed signal		•
18	Emergency stop		•
19	Auxiliary input	•	•

1000061877-IT5-B2

### 6.6 Convenience Receptacles (if applied)

The genset can be equipped with the single-phase (2 or 3 pin) and three-phase convenience receptacle (4 or 5 pin) according to the customer's requirement. The user can supply power for the loads conveniently. For the parameters of rated voltage and current refer to the machine's technical document please. Operation instructions are as follows.

- 1) Turn every circuit breaker protecting convenience receptacle to the "OFF" position.
- 2) Loosen the fixing bolts on the plug and disassembles the plug.
- 3) Connect load cables to the plug in the proper position and fix them with bolts.
- 4) Reassemble the plug and tighten the fixing bolts.
- 5) Put the plug into the convenience receptacle.
- 6) Turn the corresponding circuit breaker to the "ON" position when the genset is running, then turn on the switch of load. So power supply is sent to the load side.

Every convenience receptacle is equipped with a separate circuit breaker protecting it. While the

genset is running, if the current in one convenience receptacle is above its rated value, the corresponding circuit breaker would turn to the "OFF" position automatically and interrupt its circuit.

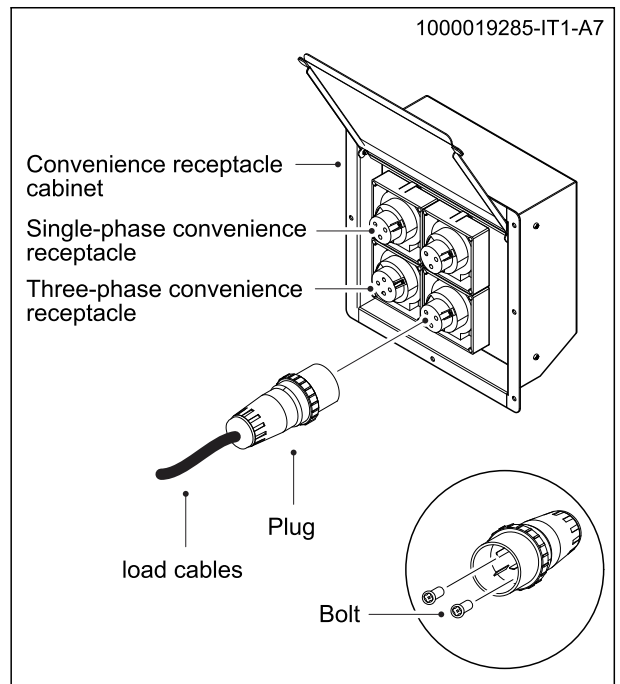

### 6.7 Terminals Diagram

#### (1) PLC-7420 Control System Terminals

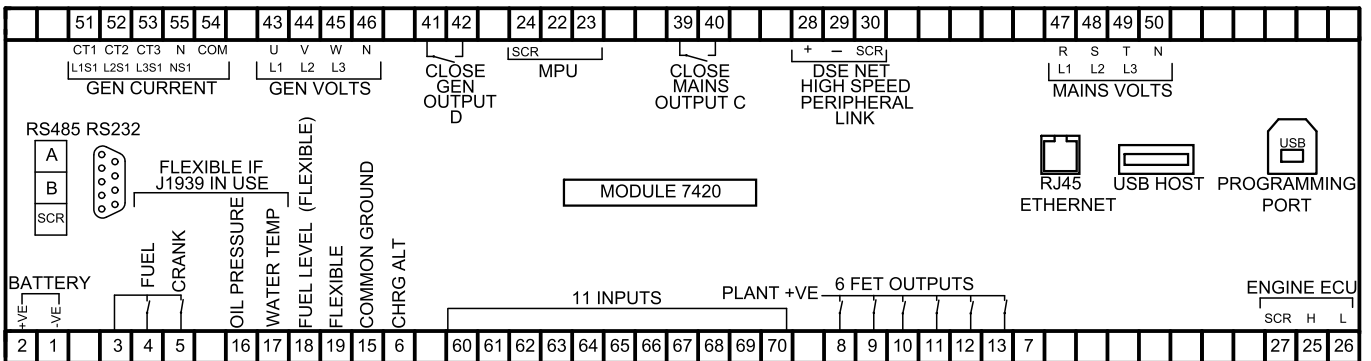

#### (2) PLC-7320 Control System Terminals

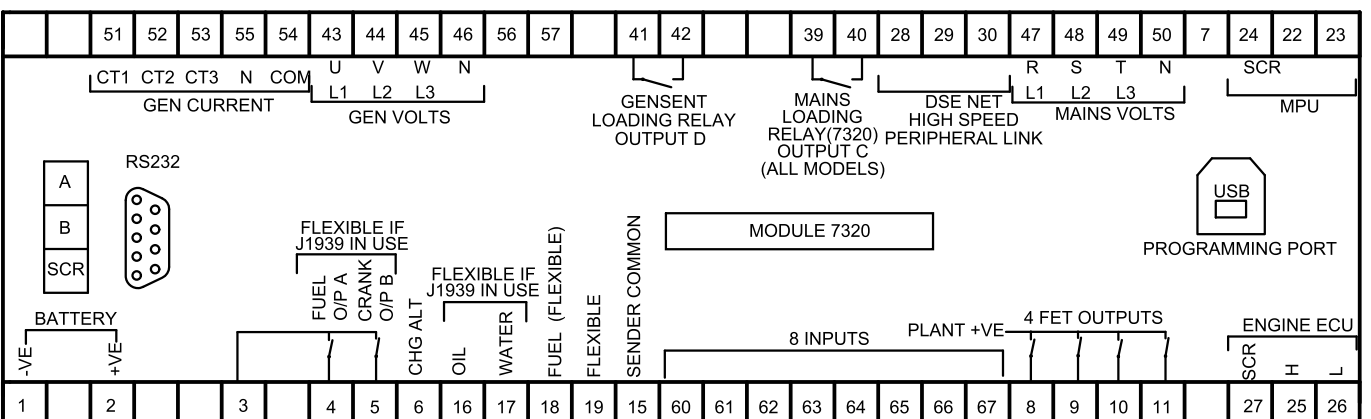

## 6.8 Parameter Configuring



### WARNING

GS-OP2

- Stop the machine before setting any parameter.
- Some parameters can be reset by the user through the control panel, and the others can only be changed using the PC utility software. Contact **POWERLINK** or our authorized distributor for technical support if you encounter a problem when configuring parameters.

Although full configuration of the module is possible using configuration software, selected parameters that may require adjustment in the field are able to be adjusted via the module's fascia.

- 1) Ensure the engine is at rest and the module is in STOP mode by pressing the **Stop Button**.
- 2) Press the **Stop button** and **Accept button** simultaneously. If a module security PIN has been set, the PIN number request is then shown:

Editor
Enter Pin # # # #

- 3) Press the **Accept Button**, the first "#" changes to "0". Press the **Up/Down Button** to adjust it to the correct value. Press the **Right Button** for next digit when the first digit is correctly entered. The

digit you have just entered will now show "#" for security. Repeat this process for other digits of the PIN number. Press the **Accept Button** after editing the final PIN digit, the PIN is checked for validity. If the number is not correct, you must re-enter the PIN.

- 4) If the PIN is correct (or the module PIN has not been enabled), the editor is displayed as below illustration. Then enter the editor interface.

Editor - Display
Contrast 53%

- 5) Press the **Left/Right Button** to cycle to the section you wish to view/change.
- 6) Press the **Up/Down Button** to select the parameter you want to view/change within the currently selected section.
- 7) Press the **Accept Button** to enter edit mode. The parameter begins to flash to indicate that you are editing the value.
- 8) Press the **Up/Down Button** to change the parameter to the required value.
- 9) Press the **Accept Button** to save the value. The parameter ceases flashing to indicate that it has been saved.
- 10) Press and hold the **Accept Button** to exit the editor at any time.

## 7 Maintenance

### 7.1 General



**WARNING**

GS-MT7

- Maintenance should be performed by a licensed engineer.
- For detailed maintenance procedures on the engine or alternator, refer to their own operation manual.
- Prior to starting any maintenance work, always stop the machine as described in these operating instructions prior to removing any safety cladding or safety devices. Refit the safety cladding or safety devices immediately upon completion of the maintenance work.
- Following the maintenance schedule and using the machine properly will bring longer life, better performance, and safer operation. Perform each maintenance procedure at the time period indicated or after the number of operating hours indicated, whichever comes first.

- Only use original spare parts, oils, coolant and operating materials released by **POWERLINK** for the maintenance work.



**WARNING**

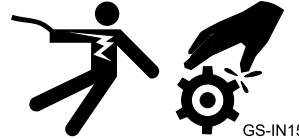

GS-IN15





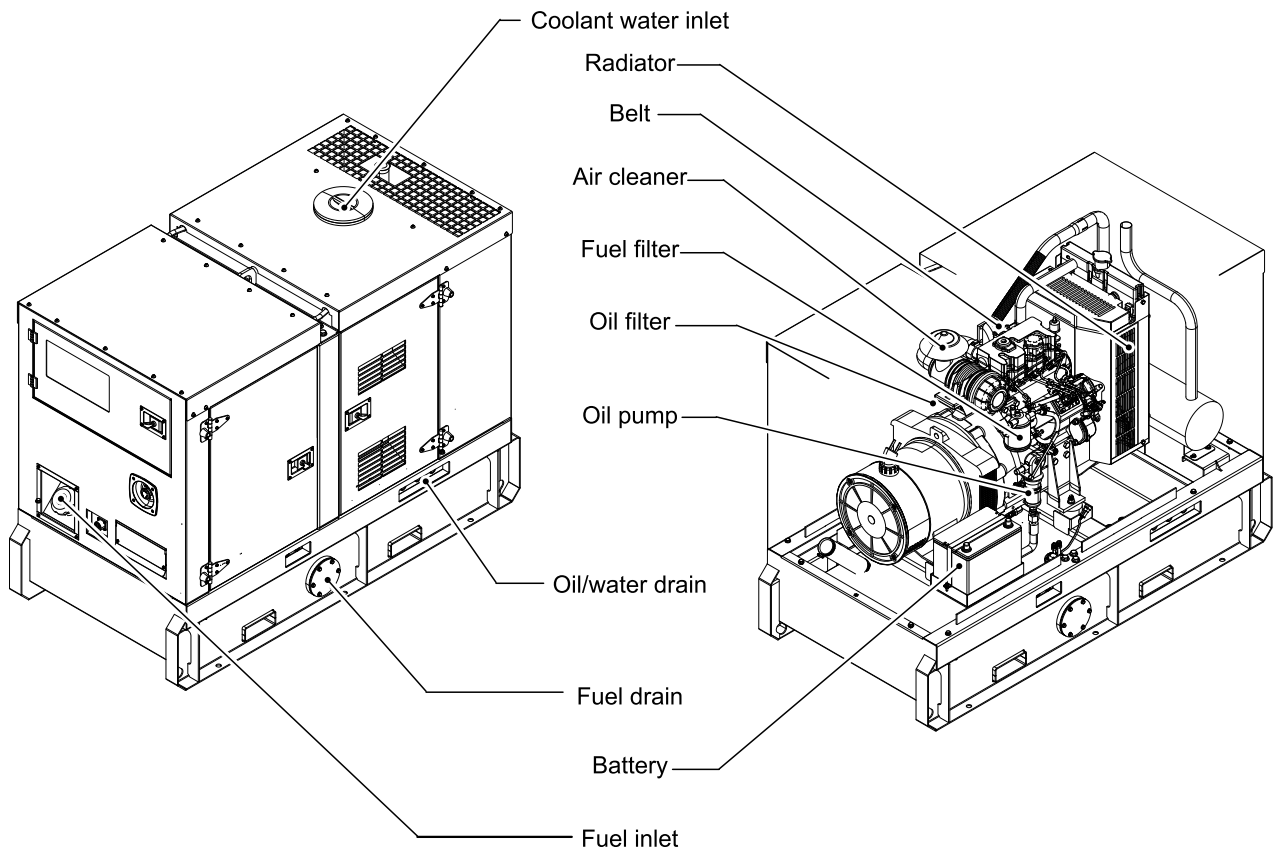





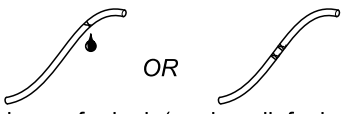
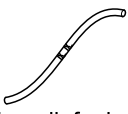

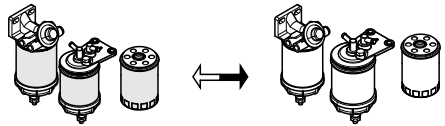

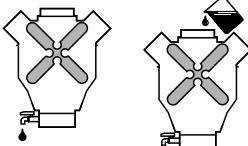

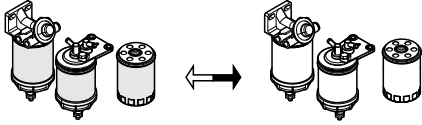

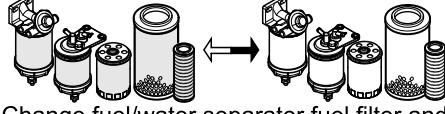
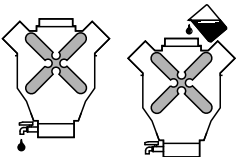
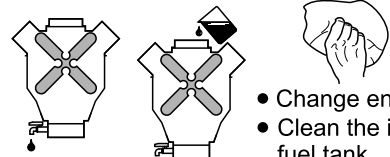
- Always adhere to the prescribed operating method described below for all maintenance work. Never omit a single safety step! Otherwise you will risk injury from restarting, electric shock or parts which may fly off.
- Before performing any check or maintenance, stop the engine and remove the start key.
- Accidental starting of the machine during maintenance can cause severe personal injury or even death, so before performing maintenance, please switch off battery switch and disconnect negative (-) cable first to reduce the risk of arcing.

### Typical Maintenance Points

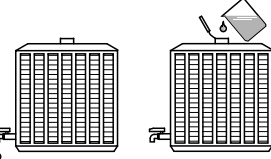
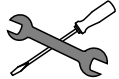
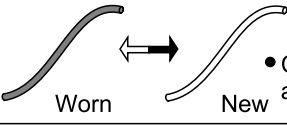

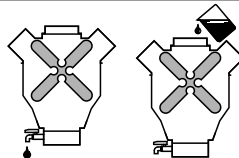
GS-MT8

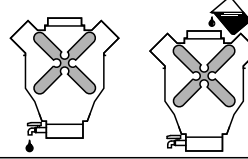
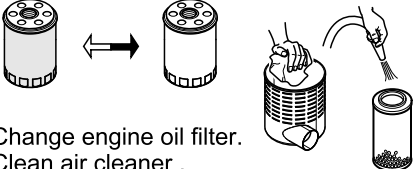
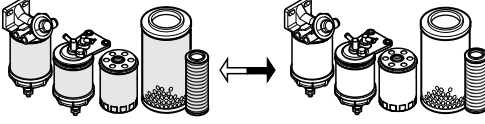
7.2 Routine Maintenance Diagram

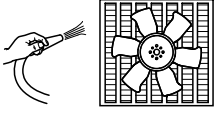
Routine Genset Maintenance		GS-MT16	
 Daily or Every 8 Hours	 OR  • Check hoses for leak (engine oil, fuel and coolant) or crack.	 Every 500 Hours	 • Change fuel/water separator, fuel filter and engine oil filter.
	 • Check various meters and alarm lamps. • Check engine oil, fuel, coolant level.		 • Change engine oil.
 First 50 Hours	 • Change fuel/water separator, fuel filter and engine oil filter.	 Every 1000 Hours or Yearly	 • Change fuel/water separator, fuel filter and engine oil filter. • Change primary and safety filter element of air cleaner.
	 • Change engine oil.		 • Change engine oil. • Clean the inside of fuel tank.
 Every 100 Hours	 • Drain water/sediment in fuel/water separator and fuel filter.	 Every 2 years or Every 2000 Hours	 • Change the coolant.
 • Tighten all electrical connections.	 • Change engine oil, fuel and coolant pipes.		
 Every 250 Hours	 • Change engine oil.	 Every 500 Hours	 • Change engine oil.
	 • Change engine oil filter. • Clean air cleaner. • Drain water/sediment in fuel tank.		 • Change fuel/water separator, fuel filter and engine oil filter. • Change primary and safety filter element of air cleaner.
 • Check fan belt tension.	 • Check and clean cooling system. • Check cooling fan for crack.	<p><b>NOTICE:</b></p> <ul style="list-style-type: none"> <li>• Always perform above maintenance schedule after the number of operating hours or year(s) indicated, whichever comes first.</li> <li>• Clean the primary filter when the maintenance indicator of the air filter displays red sign. Change the primary and safety filter (no matter how long it has run) if it has been cleaned for five times.</li> <li>• Above maintenance intervals should be shortened if the machine is often used in extreme environment. In this case, ask for help from <b>POWERLINK</b> server.</li> </ul>	

### 7.3 Generator Set Maintenance

Inspect the genset daily or after every eight hours of operation, whichever comes first. Check the mechanical, exhaust, fuel, and DC electrical systems as described below.

#### (1) New Machines

- *Run the genset at least 60–100% of continuous load for the first 100 hours.*
- *Change engine oil and replace oil filter after the first 50 hours.*

#### (2) Mechanical System

Inspect any signs of mechanical damage. Start the genset and listen for any unusual noise, which may indicate mechanical problems. Repair them immediately if necessary.

Inspect the mounting fasteners to make sure the genset is secure in its compartment. If use an under-floor housing, make sure that the genset is secured to the housing.

Check the genset air inlet and outlet area, make sure that they are not blocked with debris.

Clean the machine immediately whenever dust and dirt begin to accumulate. Usually remove dust and dirt with a damp cloth.



GS-MT7

- *Do not clean the genset when the engine is running.*
- *Protect the alternator, air cleaner, control panel, and electrical connections from cleaning solvents because cleaning solvents can damage electrical connectors.*

#### (3) Exhaust System

Start the genset, inspect the entire exhaust system including the exhaust pipe, exhaust elbow and muffler during the machine running.

Visually and audibly check for leaks at all connections, welds, gaskets, and joints.

If any leaks are found out, shut down the machine and do not operate until corrected. Replace corroded exhaust components if necessary before leaks occur.



GS-MT19

- *Inhalation of exhaust gas can result in severe personal injury or even death. Check exhaust system audibly and visually for leaks daily. Repair all leaks immediately if necessary.*

#### (4) Fuel System

Start the genset, inspect the fuel supply lines, return lines, filters, and fittings for leaks during the machine running.

Inspect all flexible sections for cuts, cracks and abrasions. Make sure that the fuel lines do not rub against anything that could break them. Replace worn fuel line components if necessary before leaks occur.



GS-MT3

- *Fuel leakage will cause a fire hazard which can result in severe personal injury or even death if ignited. When checking for leaks, do not smoke or allow any spark, flame or other ignition source in the area. If any leaks are found out, repair them immediately.*

#### (5) DC Electrical System

Inspect the battery terminals for clean and connections for tight with the genset off. Loose or corroded connections may cause resistance which can impede starting. Clean and reconnect loose battery cables if necessary.

In order to reduce the possibility of arcing, always disconnect the negative (-) battery cable first and connect it after maintaining.



GS-MT13

- *Ignition of explosive battery gas can create severe personal injury.*
- *Wear goggles, protective rubber gloves and apron and do not smoke while servicing batteries.*

## 7.4 Air Cleaner

### 7.4.1 Clean air filter element

- 1) Loosen clips on the air cleaner housing and remove the dust cap.
- 2) Remove the air filter element.
- 3) Blast the compressed air to the air filter element from inside.
- 4) Use a clean cloth to wipe the filter sealing surface and the inside of the outlet tube.
- 5) Reinstall the air cleaner in the reverse order.

### 7.4.2 Change air filter element

- 1) Loosen clips on the air cleaner and remove the dust cap.
- 2) Remove the air filter element.
- 3) Change a new air filter element.
- 4) Reinstall the air cleaner in the reverse order.



- Do not remove the air cleaner while operating or immediately after stopping the machine.

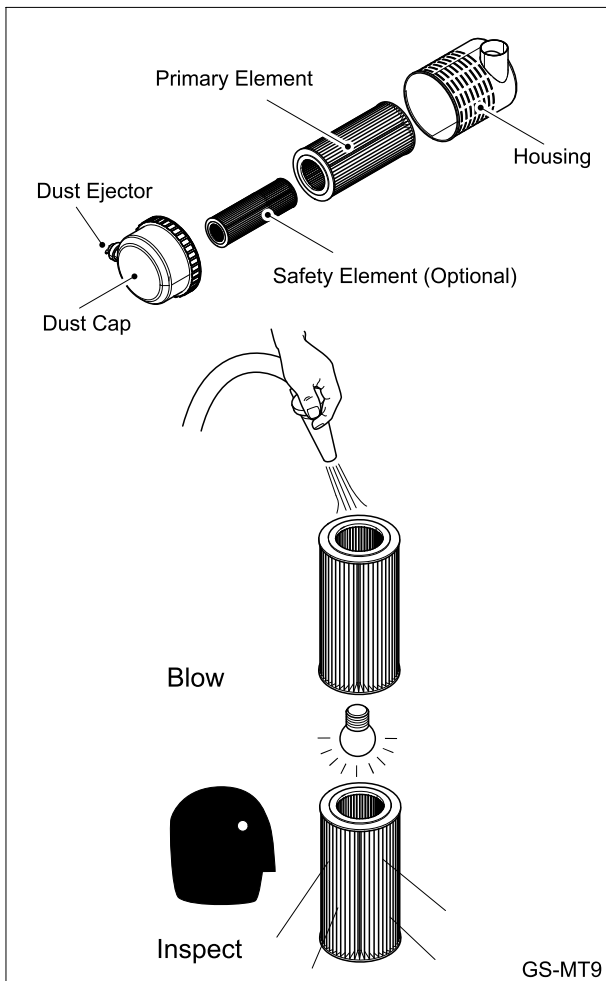

## 7.5 Engine Coolant

### Change coolant

- 1) Turn on the drain ball valve which is on the side of the genset base frame, then turn on the drain plug at the bottom of the radiator and drain coolant.
- 2) After draining, turn off the drain ball valve, then turn off the drain plug.
- 3) Adding coolant.

**Note:**





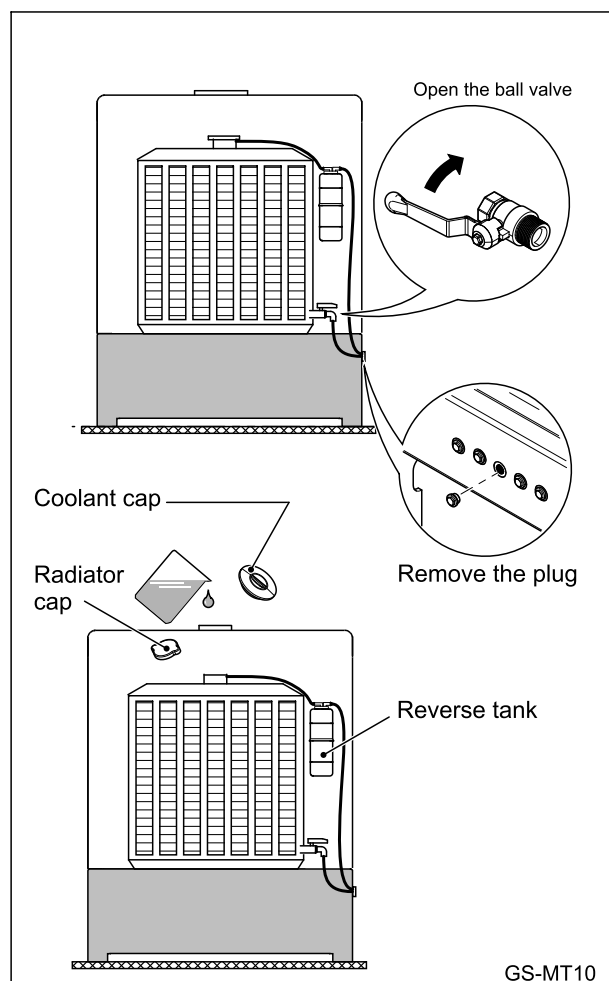

Refer to **4.5 Checking Coolant Level** for details of adding coolant.



- Do not change coolant while operating the genset or immediately after stopping the machine, because that may cause burns from hot vapour or coolant.



7.6 Engine Oil and Oil Filter

 <b>WARNING</b>						
--------------------------------------------------------------------------------------------------	-----------------------------------------------------------------------------------	-----------------------------------------------------------------------------------	-----------------------------------------------------------------------------------	-----------------------------------------------------------------------------------	-----------------------------------------------------------------------------------	-------------------------------------------------------------------------------------

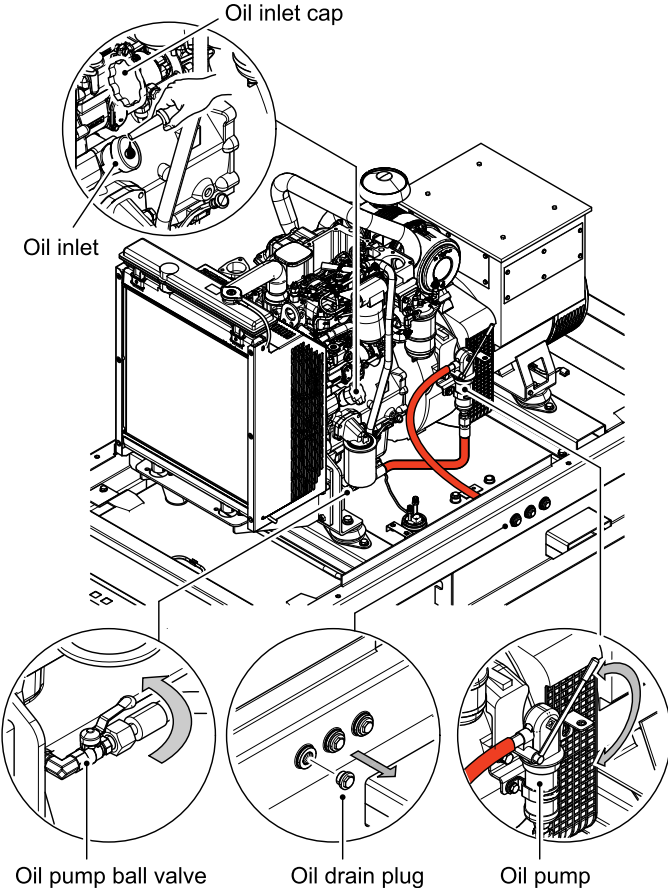

**CAUTION**



**1. Change engine oil**

- 1) Remove the oil drain plug on the side of the base frame.
- 2) Open the access door.
- 3) Turn on the oil pump ball valve which is under the oil pan or oil pump.
- 4) Twitch the oil pump or handle the lever on the oil pump to drain engine oil.
- 5) After draining, turn off the oil drain ball valve and oil pump ball valve.
- 6) Loosen and remove the oil inlet cap, add oil into the oil inlet through an outside oil filter until the level is slightly less than the upper limit by checking the oil level on the oil gauge.
- 7) Tighten the oil inlet cap and close the access door.

**2. Change oil filter**

- 1) Drain engine oil fully.
- 2) Loosen and remove the oil filter by using an oil filter wrench.
- 3) Add engine oil into a new oil filter and fill it up.
- 4) Smear a little engine oil on the rubber gasket of the new oil filter.
- 5) Screw the new filter into place and tighten it until the gasket contacts the seal surface. Then, give it additional 1/2 turn by using the oil filter wrench.
- 6) Supply engine oil.

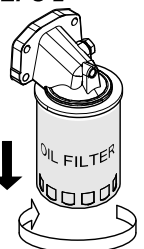
<p><b>STEPS 2</b></p> 	<p><b>STEPS 3</b></p> 	<p><b>STEPS 4</b></p> 
		
<p><b>STEPS 5</b></p> 		

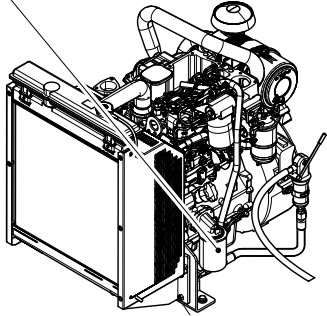
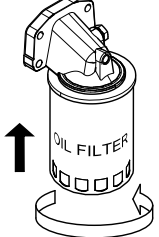
**WARNING**

- Wear protective gloves, goggles and clothes when changing the engine oil.
- Do not remove the oil filter or change engine oil while operating the genset or immediately after stopping the machine.
- Take a plastic sheet and a container under the oil drain outlet to protect environment. Disposal of the waste liquid should be in accordance with the local environmental protection legislation.

GS-MT11

7.7 Fuel Filter

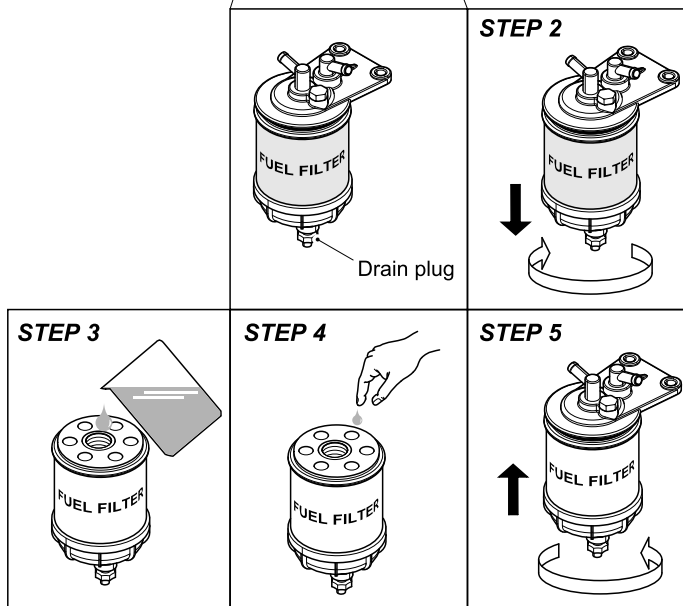
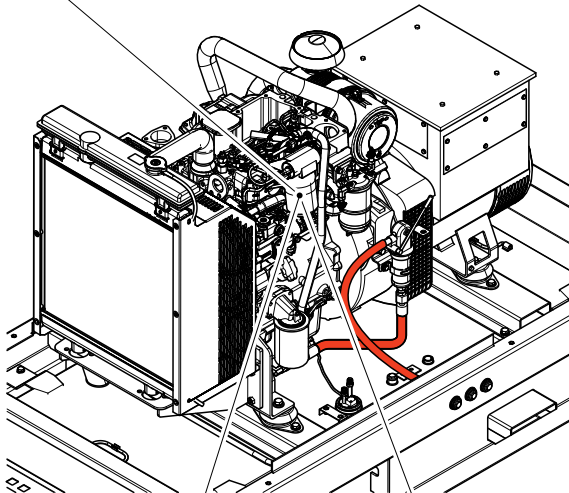
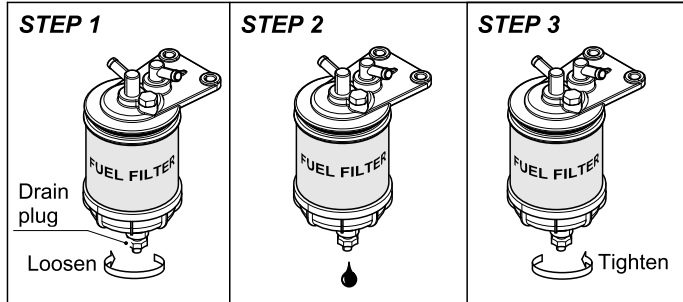

**1. Drain water / sediment in the fuel filter**

- 1) Loosen the drain plug.
- 2) Drain water and sediment until fuel inside starts to come out.
- 3) Tighten the plug.

**2. Change fuel filter**

- 1) Loosen the drain plug to drain water and fuel until the fuel inside does not come out from the plug.
- 2) Loosen the bowl by using the filter wrench. Remove the fuel filter.
- 3) Add fuel into a new fuel filter and fill it up.
- 4) Smear a little fuel on the rubber gasket of the new fuel filter.
- 5) Screw the bowl and the new filter into place and tighten it until the gasket contacts the seal level. Then, give it additional 1 turn by using the filter wrench.



• Do not smoke or use flame near the engine or fuel resource, because that may cause fire.

• Wear protective gloves, goggles and clothes when changing the fuel filter. In addition, the waste fuel should be collected in a container for environmental protection. Disposal of the waste liquid should be in accordance with the local environmental protection legislation.mediately after stopping the machine.

7.8 Fuel-water Separator (If applied)

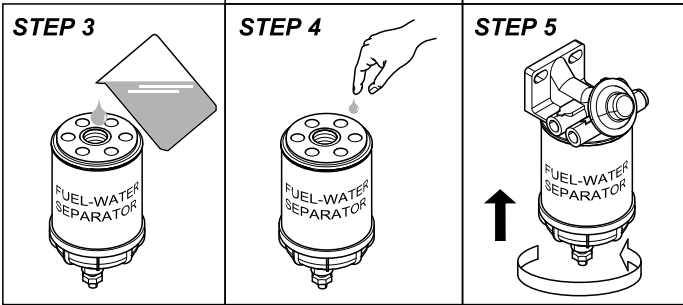
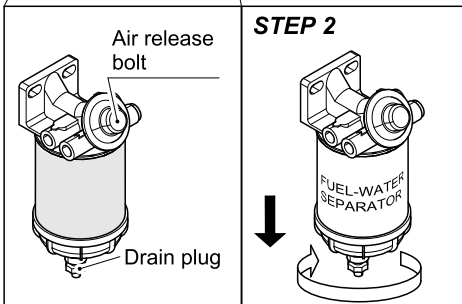
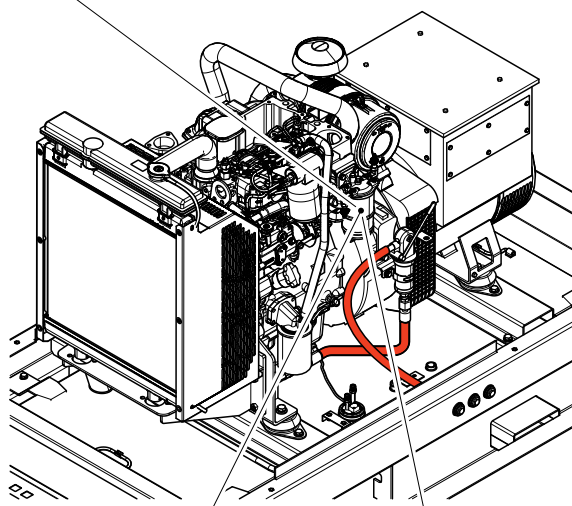
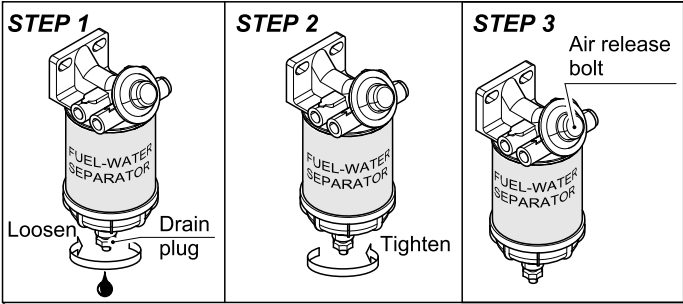

**1. Drain water and sediment**

- 1) Loosen the drain plug. Drain water or other sediment until the fuel starts to come out.
- 2) Tighten the drain plug.
- 3) Loosen air release bolt. Extract the air in the oil-water separator. (Refer to **Checking Fuel** for air extracting )
- 4) Tighten the bolt.

**2. Change fuel-water separator**

- 1) Loosen the drain plug, drain water and fuel until the fuel does not come out from the plug and then tighten the drain plug. Loosen air release bolt. Extract the air. Tighten the bolt.
- 2) Loosen and remove the separator by using a separator wrench.
- 3) Add fuel into the new separator and fill it up.
- 4) Smear a little fuel on the rubber gasket of the fuel-water separator.
- 5) Screw the new separator into place and tighten it until the gasket contacts the seal surface. Then, give it additional 1 turn by using the separator wrench.



• Do not smoke or use flame near the engine or fuel resource, because that may cause fire.

• Wear protective gloves, goggles and clothes when changing the fuel filter. In addition, the waste fuel should be collected in a container for environmental protection. Disposal of the waste liquid should be in accordance with the local environmental protection legislation.mediately after stopping the machine.

7.9 Battery Maintenance

The user should check and charge the battery periodically. The power of battery will decrease while it is unused for a long period of time or start failure repeatedly. Charge it in time while these occurred.



- Batteries present the hazard of explosion that can result in severe personal injury.
- **NEVER** smoke or allow any fire, flame, spark, pilot light, arc-producing equipment or other ignition sources around the battery area.
- Do not disconnect battery cables while the machine is cranking or running because explosive battery gases could be ignited.
- Battery electrolyte can cause severe eye damage and burns to the skin. Wear goggles, rubber gloves and other protective device when working with batteries.

7.9.1 Battery cable disconnecting

**ALWAYS** be sure the battery cables are properly connected to the battery terminals as shown below. The Red Cable is connected to the positive terminal of the battery, and the Black Cable is connected to the negative terminal of the battery.

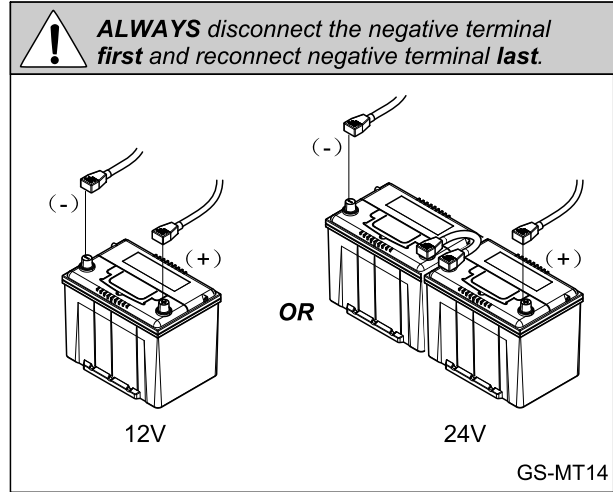

7.9.2 Battery power checking

**POWERLINK** adopts maintenance free battery. So it is not necessary to add distilled water or electrolyte, only check the coulomb periodically.

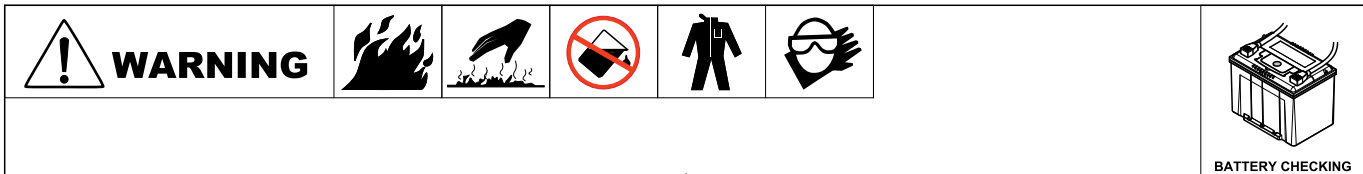

1 Check the color inside the magic eye

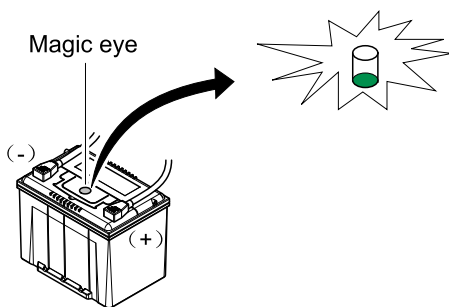

2 Measure the battery's voltage

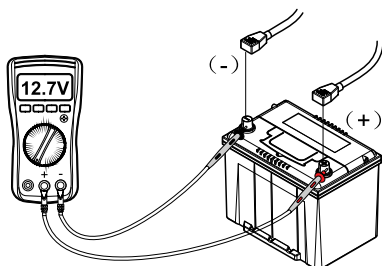

Check the battery's coulomb (every month)

Two ways are as below:

1. Check the color inside the magic eye (it is on the top surface of the battery):

- Green: The coulomb is sufficient.
- Black: The coulomb is insufficient (short of coulomb). Charge the battery in time please.
- White: The battery is damaged. Replace it please.

2. Measure the battery's voltage:

Battery Voltage			
Season	Sufficient Coulomb	Insufficient Coulomb	Badly insufficient Coulomb
Summer	> 12.4V	11.0-12.4V	< 11.0V
Winter	> 12.6V	11.2-12.6V	< 11.2V

**CAUTION**

- Never store the battery under short of coulomb. Charge the battery in time if the coulomb is insufficient.
- If the battery is badly short of coulomb, charge it together with one good battery (paralleling them). When its voltage rises up to 11.0V (11.2V in Winter), charge it alone.

GS-MT33



### 7.10 Lifting and Transporting

The top of the genset has one or several lifting lugs attached to the lifting frame inside the housing. Refer to the Technical Data for the weight of the genset. Make sure the lifting devices have enough capacity to lift the unit safely. When lifting the genset, attach a sling securely to the lifting lug.

When transporting the genset, it should be secured properly with ropes tied to the roping lugs at the top of the genset for fixing.



GS-MT7

- Do not use lifting points located over the engine, alternator or other components.
- Inspect lifting lugs for dents, damage, weld or parent metal cracks or other discrepancies. Replace or repair it before lifting if anything is improper.
- Do not stand nearby while lifting.

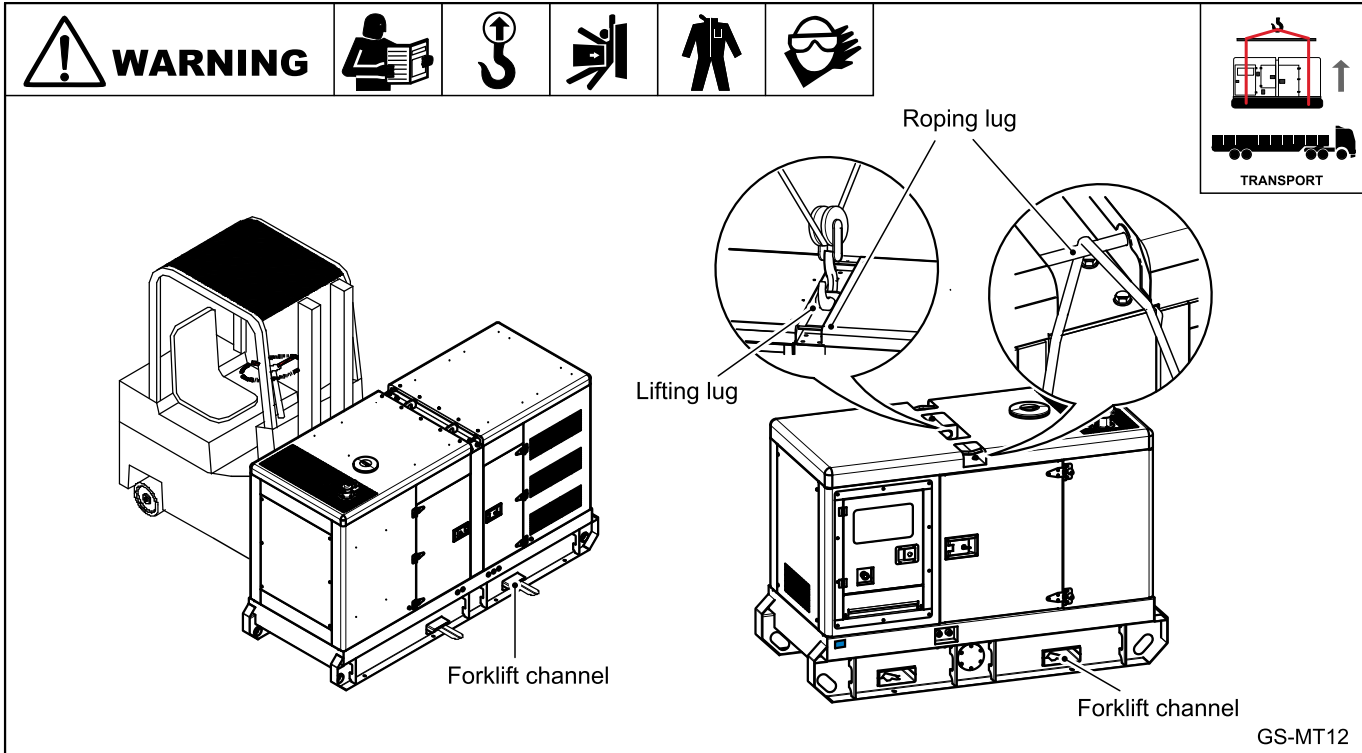

GS-MT12

### 7.11 Overnight Storage

Proper operation is essential for preserving top genset performance and reliability when storing the genset overnight.

- 1) Check and make sure the engine battery switch and all genset circuit breakers are placed "OFF" position.
- 2) Make sure that the control cabinet and access doors are closed and padlocked.
- 3) Turn off the fuel supply valve (if equipped).



GS-MT7

- Do not store it overnight in a low lying area that might fill with water during a heavy storm.

### 7.12 Long-term Storage

If the genset would not be used for more than two months, perform the following procedures to store it.

- 1) Make sure the engine battery switch and all genset circuit breakers are placed "OFF" position.
- 2) Close and padlock the control cabinet and access doors. Remove the start key.
- 3) Turn off the fuel supply valve (if equipped).
- 4) Disconnect the battery cables (negative [-] cable first) from the starting battery and store the battery.
- 5) Store the genset where dust and humidity are less as possible.
- 6) The genset should be running in 30% rated load until it reach a stable operating temperature once every six months. Meanwhile it should be running in full load in order to prevent oil pollution jam in exhaust system once every year.

## 8 Trailer Operation & Maintenance (if applied)

### 8.1 General

**POWERLINK** provides portable generator set solution to satisfy the demand of transportation. The user could select a trailer for their generator set. Generally speaking, the trailer could divide into 2 types: Highway type and Non-highway type.

#### Highway type

This type of trailer is designed with service brake. For safety, recommend the running speed doesn't exceed 80km/h.

#### Non-highway type

This type of trailer is designed without service brake. For safety, recommend the running speed doesn't exceed 20km/h.



TR-OP1

#### Be careful!

Besides these, the coupler maybe unlike in different countries; check and make sure the trailer and its coupler are correct and follow the guideline of governmental agencies for trailing. Failure to follow these procedures may seriously harm to the equipment and cause seriously hurt even death during trailing.

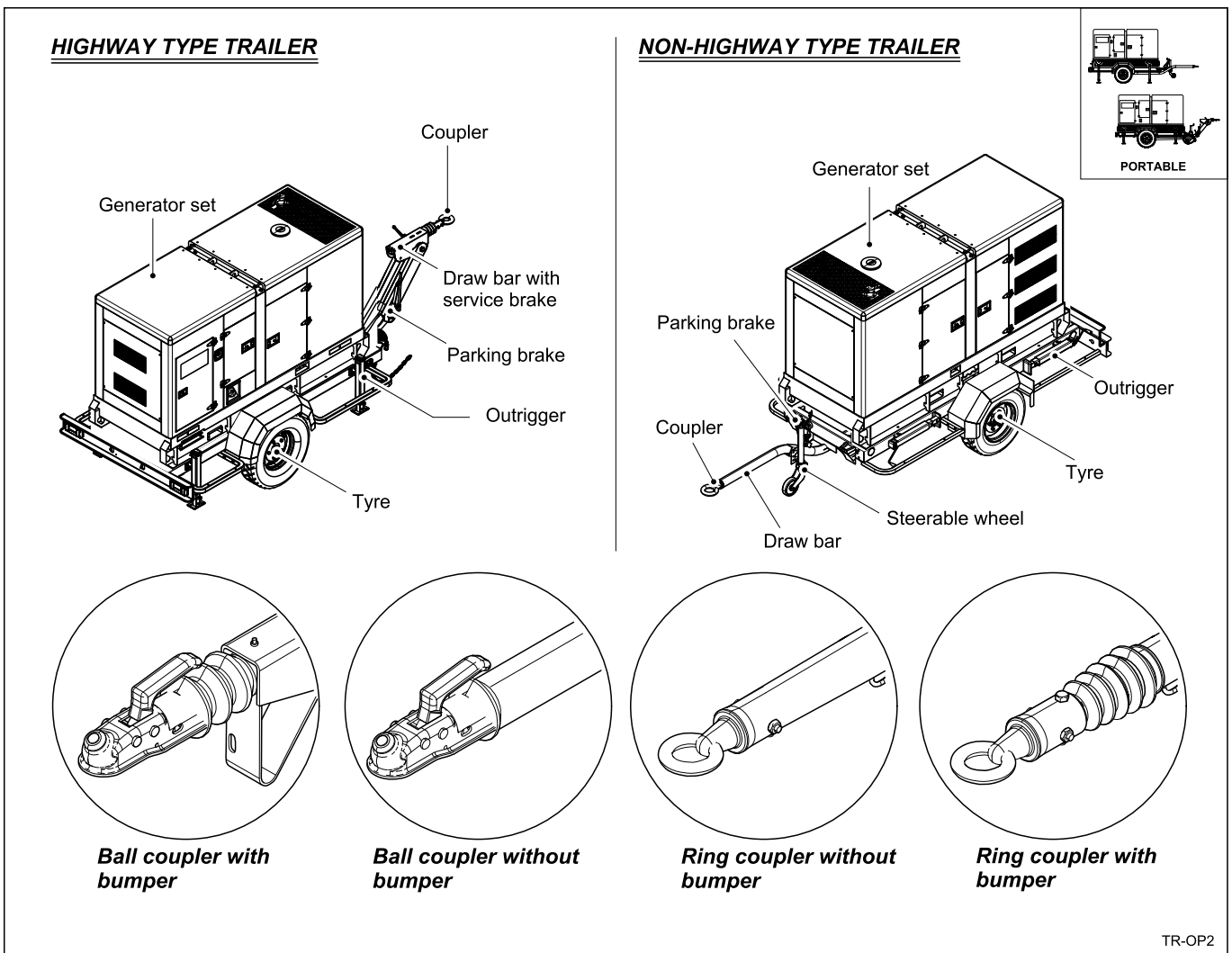

TR-OP2

## 8.2 Assembling instructions

### 8.2.1 General Inspection Prior to Assembling

The trailer is dismantled into parts to pack for convenient transit. The customer should assemble them before using.



**CAUTION**



GS-IN42

Every trailer has been thoroughly inspected prior to shipment from the factory. However, be sure to check for damaged parts or components during transportation, or loose nuts and bolts, which could have occurred in transit.

- Ensure all safety labels are legible and in place. Clean or replace as required if necessary.
- Inspect the machine structure to ensure there is no crack or other discrepancies in the profile of the machine, welding leg or the body.

### 8.2.2 Assembling instructions



**WARNING**

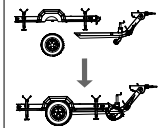

Typical single-axle trailer assembling diagram

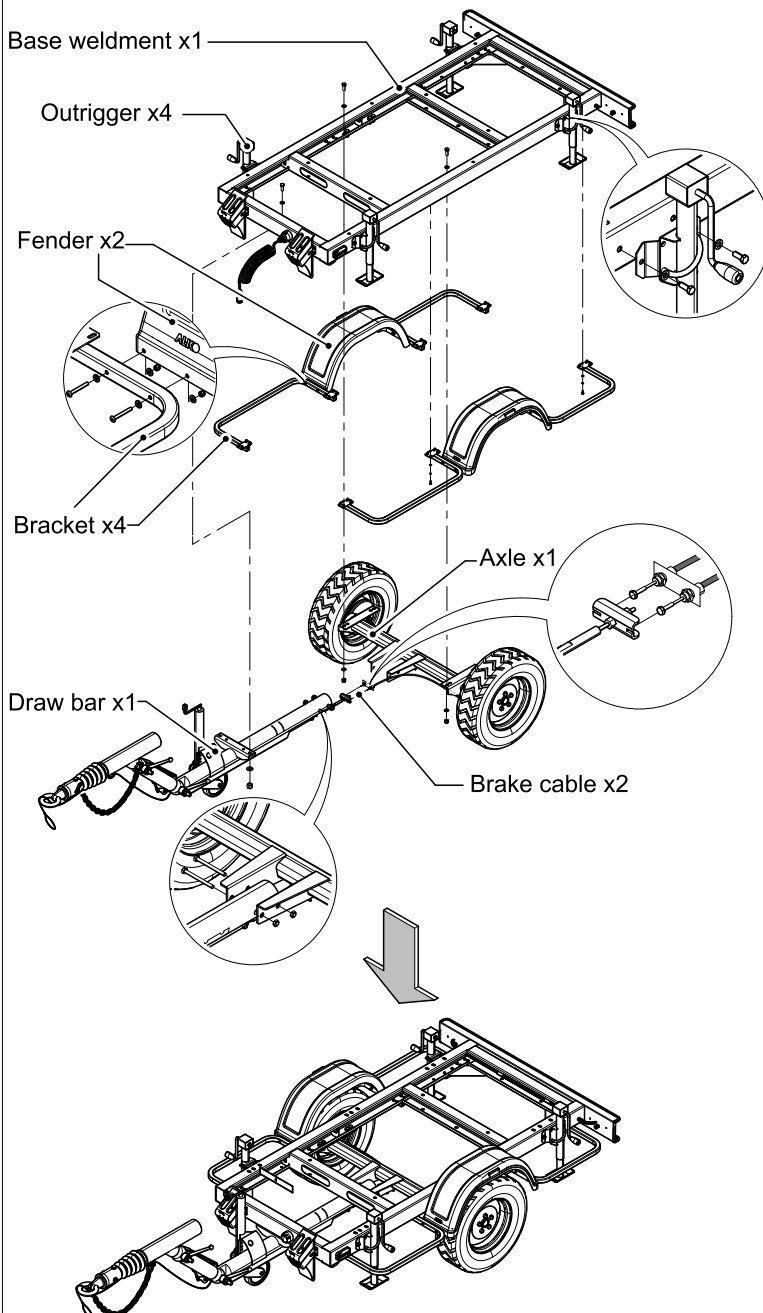

**WARNING**

#### Trailer Assembly

- 1) Fix the outrigger and base weldment with hexagonal bolts and flat washers.
- 2) Fix the fender and bracket with screws and nuts.
- 3) Fix the bracket and base component with hexagonal bolts, springs washers and flat washers.
- 4) Fix the drawbar and axle with hexagonal bolts and nuts.
- 5) Fix the trail component and base component with hexagonal bolts, flat washers and nuts.



**CAUTION**

- Number and dimension of hexagonal bolts, screws, flat washers, spring washers and nuts above are decided by the number and location of installation holes located on the components.
- After assembling the trailer, the user must maintain the brake system. The method refers to the section of **Brake system maintenance**.

TR-OP12



**WARNING**

Typical dual-axle trailer assembling diagram

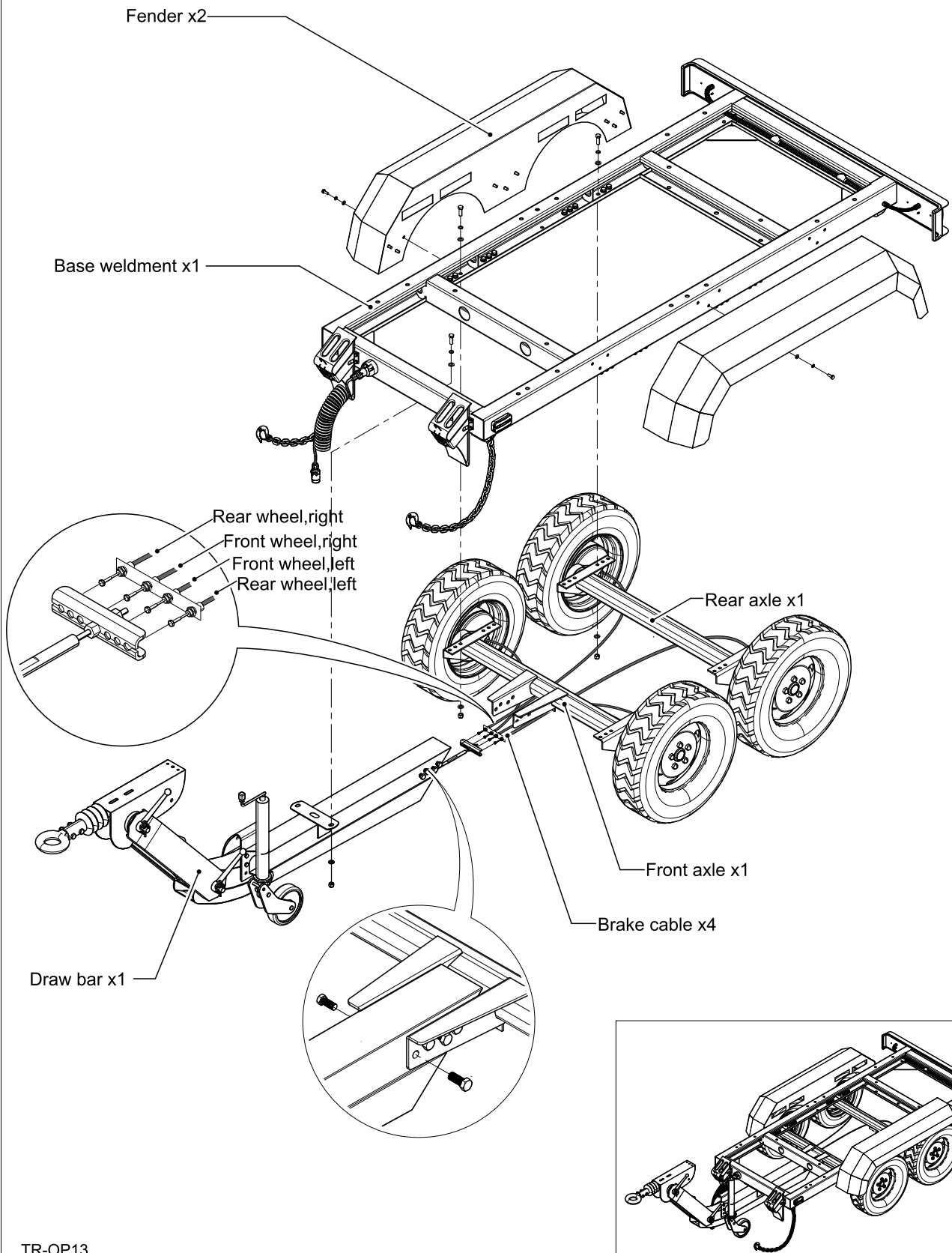
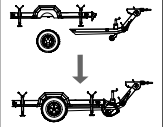



**WARNING**

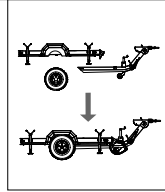

**Install the Taillight and Sidelight**

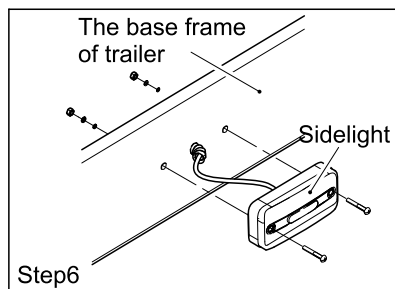
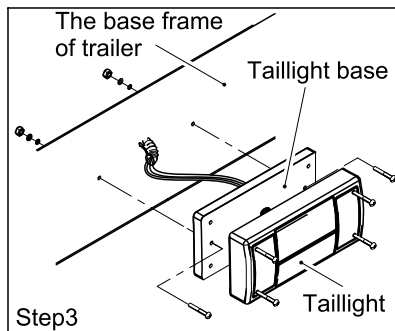
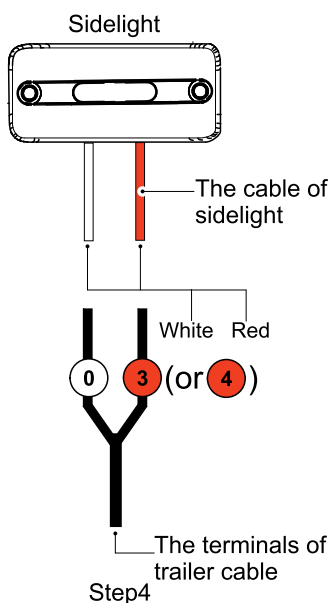
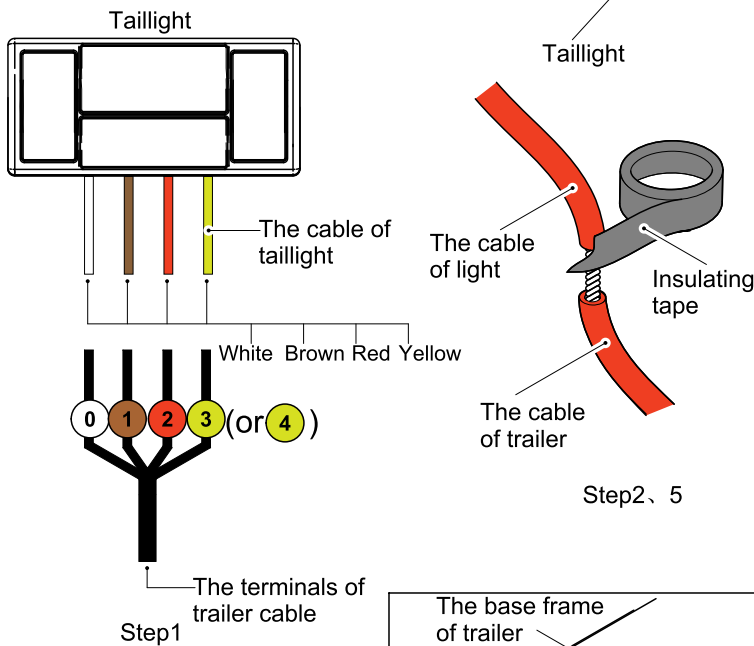
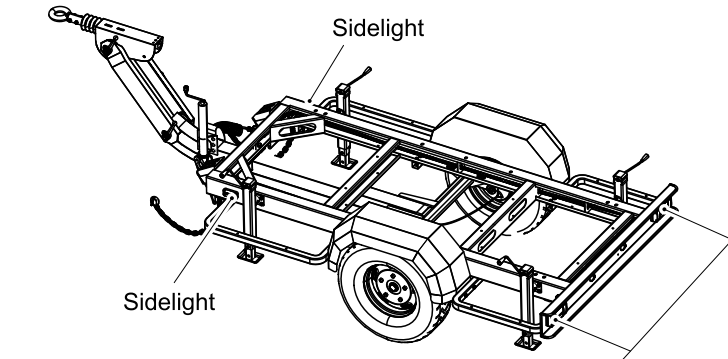

**Install the taillight:**

1) Connect the terminals of the trailer cable and the cable of the taillight as the table below:

Color of taillight cable	White	Brown	Red	Yellow
Tube of the left taillight cables	0#	1#	2#	3#
Tube of the right taillight cables	0#	1#	2#	4#

2) Wrap the cables at the lap joint with the insulating tape to avoid creepage.

3) Fix the taillight base and the trailer base frame with bolts, flat washers, spring washers and nuts. Then screw the bolts located in the corner of the taillight and make sure it is firm.

**Install the sidelight:**

4) Connect the terminals of the trailer cable and the cable of the sidelight as the table below:

Color of sidelight cable	White	Red
Tube of the left sidelight cables	0#	3#
Tube of the right sidelight cables	0#	4#

2) Wrap the cables at the lap joint in the insulating tape.

6) Fix the sidelight and the trailer base frame with bolts, flat washers, spring washers and nuts.

TR-OP14

8.3 Installation Instructions



**CAUTION**



- Ensure that setting work is only carried out by specialists or appropriately trained persons.
- Ensure that generator set has been stopped and the access doors has been closed.
- Ensure that any forklift, overhead crane or other lifting or supporting device is full capable of supporting and stabilizing the weight to be lifted.
- Wear protective equipment such as safety glasses, leather gloves, heavy shirt and trousers and high shoes when working.

**WARNING: Risk of injury!**

Always adhere to the prescribed operating method described below for all setting work. Never break a single safety rule! Otherwise you will risk injury from moving parts, free swinging or unsecured components when lifting or placing loads.

**Setting work operation rules**



**WARNING**

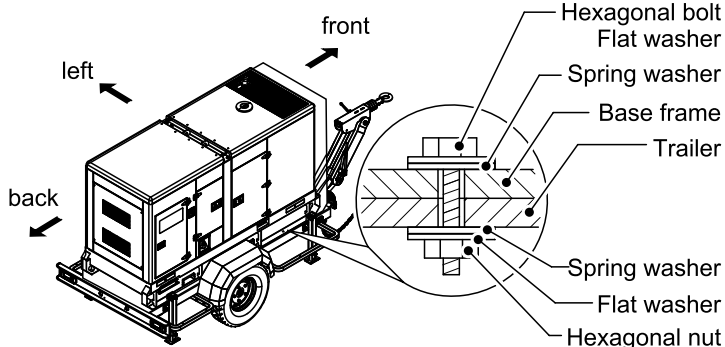
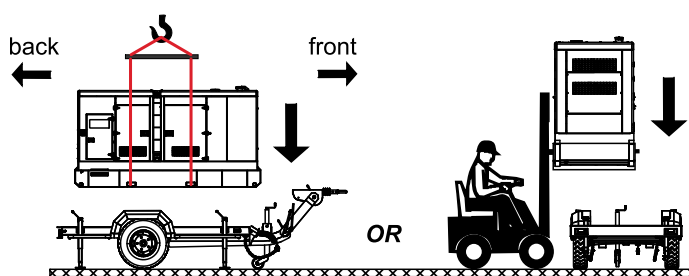
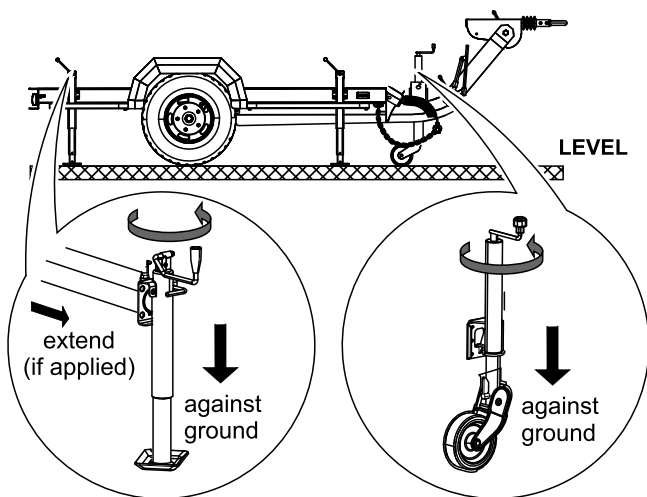
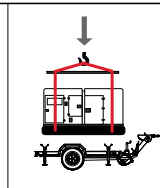

**WARNING**

**Generator-trailer Installation**

- 1) **ALWAYS** place trailer on firm level ground before install the generator set.
- 2) Operate the parking brake handle and secure it against unintentional slipping.
- 3) Rotate the handle of the steerable wheel until it snaps into the ground.
- 4) Extend the outriggers, lower them down by rotate the handle until it against the ground firmly.
- 5) Lift the generator set up, put it down on the trailer gently according to the direction in the left figure.
- 6) Fix the base frame of generator set with hexagonal lockable bolts, nuts, flat washers and the spring washers whose number decided by the installation holes located on the base frame of generator set.

## 8.4 Towing Instructions

### 8.4.1 Towing safety



- **ALWAYS** check that the drawbar and coupler on the vehicle are rated equal to, or greater than, the trailer's "gross vehicle weight rating".
- **ALWAYS** inspect the drawbar and coupler for wear or damage. **NEVER** tow the trailer using defective parts.
- **ALWAYS** make sure the coupler is securely fastened to the vehicle.
- **ALWAYS** check the tires on the trailer for tread wear, inflation, and condition. Replace worn tires.
- **ALWAYS** connect the breakaway cable to the rear bumper or frame of the vehicle. **NEVER** attach it to the drawbar.
- **ALWAYS** connect the safety chains.
- **ALWAYS** test the service brakes (if applied) on the trailer and the brakes on the vehicle that will be used for towing.
- **ALWAYS** make sure directional and trailer lights are connected and working properly.
- **ALWAYS** check that the lug nuts holding the wheels are tight and that none are missing.
- When the trailer parks for a short time, pull the handbrake to fasten the trailer firmly. If the trailer parks on the incline, **always** take the wheel chocks to underlay the wheels so that the trailer would not move.

### 8.4.2 Towing



**Be careful! Never break a single operation step!**

**NOTE:** When towing, maintain extra space between vehicles and avoid towing on soft shoulders, curbs and sudden lane. If you have not pulled a trailer before, practice turning, stopping, and backing up in an area away from heavy traffic.

The generator trailer is equipped with brakes, lights, and coupler connection. Before towing the generator, perform the following:

- 1) Check that the towing vehicle and drawbar have a rating equal to or greater than the "gross vehicle weight rating".

- 2) Check the condition of both the coupler and drawbar. **NEVER** tow the trailer if the coupler or drawbar is damaged.
- 3) Retract the jockey wheel and outrigger, and fasten them with lock-pin firmly.
- 4) Connect the cable of to directional and running lights to the vehicle, Check that are working well.
- 5) Connect the safety chains using a crossed pattern under the trailer tongue.
- 6) On trailers with service brake, connect the breakaway cable on the trailer coupler to the rear bumper or frame of the vehicle. This cable will actuate the brake system on the trailer if both the coupling and safety chains have failed. The breakaway cable is not a parking brake and should not be used as one.
- 7) Check that all fasteners on the coupling are secure.
- 8) Check the tread wear and inflation on tires. Make sure that all lug nuts are in place and are tight.
- 9) Check the operation of the service brake if applied by braking the vehicle at a slow speed before entering traffic. Make sure both the vehicle and the trailer should brake smoothly.

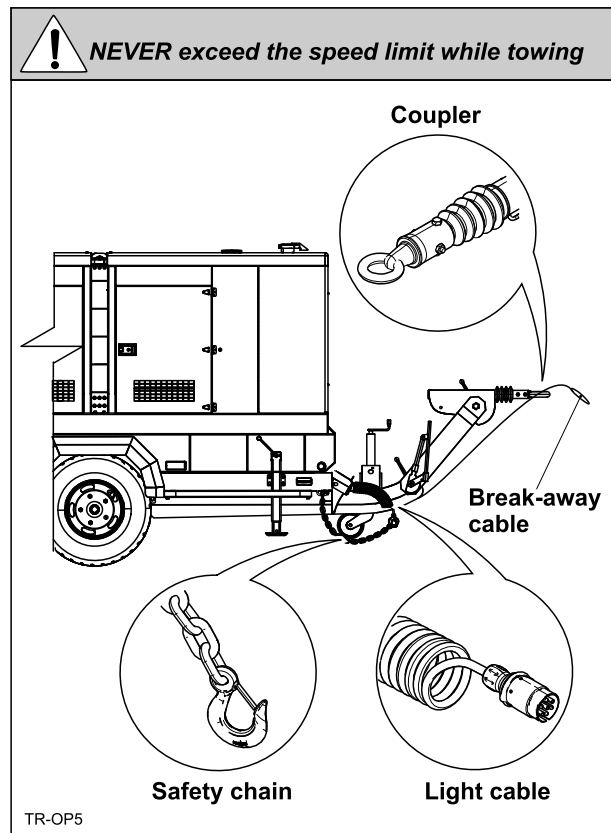

### 8.5 Trailer Maintenance

Trailer comprises suspension, frame, drawbar components, brake system, signal light system etc.

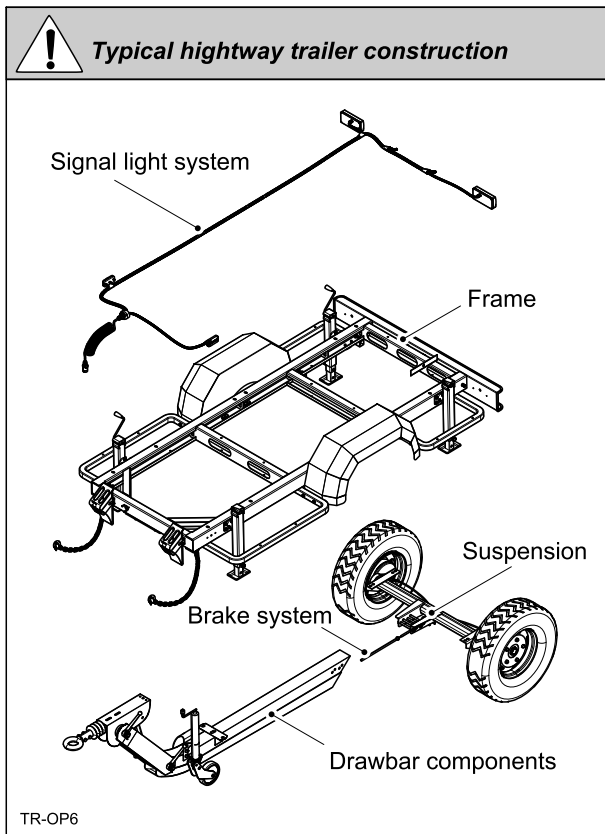

Tire inflation pressure is the most important factor in tire life. Pressure should be checked cold before operation. **Never** bleed air from tires when they are hot! Check inflation pressure weekly during use to insure the maximum tire life and minimum tread wear.

! <b>Tire Wear Troubleshooting</b>		TR-OP8	
Wear Pattern	Cause	Solution	
Centre wear	Over inflation	Adjust pressure to particular load per tire manufacturer.	
Edge wear	Under inflation	Adjust pressure to particular load per tire manufacturer.	
Side wear	Loss of camber or overloading	Make sure load does not exceed axle rating. Align wheels.	
Toe wear	Incorrect toe-in	Align wheels.	
Cupping	Out-of-balance	Check bearing adjustment and balance tires.	
Flat spots	Wheel lockup and tire skidding	Avoid sudden stops when possible and adjust brakes.	

#### 8.5.1 Suspension maintenance

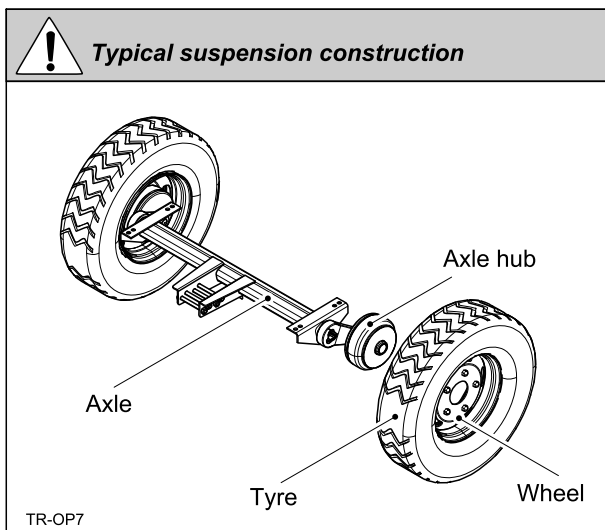

#### Axle Hubs

Grease axle hubs through grease fittings using a good wheel bearing grease.

#### Wheels

Check that lug nuts holding wheels are tight. Replace any missing nuts immediately.

#### Tires

Keep tires inflated to the proper pressure as shown on the tire sidewall, and check tread periodically for wear. Replace tires as required.

#### 8.5.2 Brake system maintenance

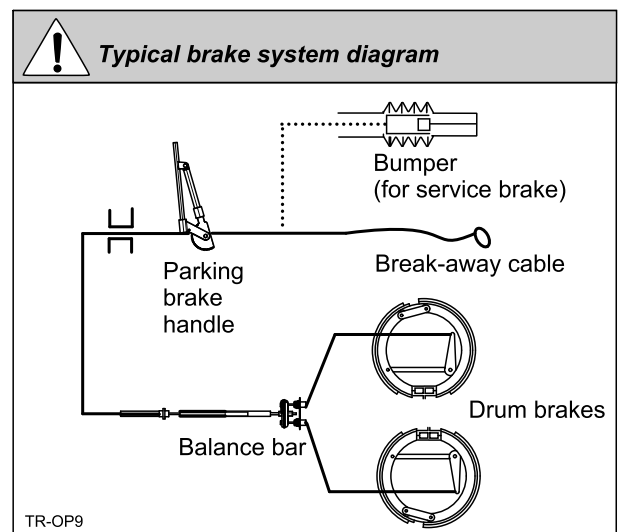

#### • Drum brake adjustment

- 1) Control the thickness of the brake shoes. If less than 2mm, the brake shoes (left and right) must be changed. The brake must be adjusted after changing the brake shoes.
- 2) Lift the trailer using a suitable jack and make sure the jack stands are placed on secure level ground.
- 3) Remove the adjusting hole cover from the adjusting slot at the bottom brake backing plate.

- 4) With a screwdriver or standard adjusting tool, rotate the star wheel of the adjuster assembly to expand the brake shoes.
- 5) Adjust the brake shoes outward until the pressure of the lining against the wheel drum makes the wheel difficult to turn.
- 6) Adjust, rotate the star wheel in the opposite direction until the wheel rotates freely with slight lining drag.
- 7) Replace the adjusting hole cover and repeat steps on the remaining brakes.

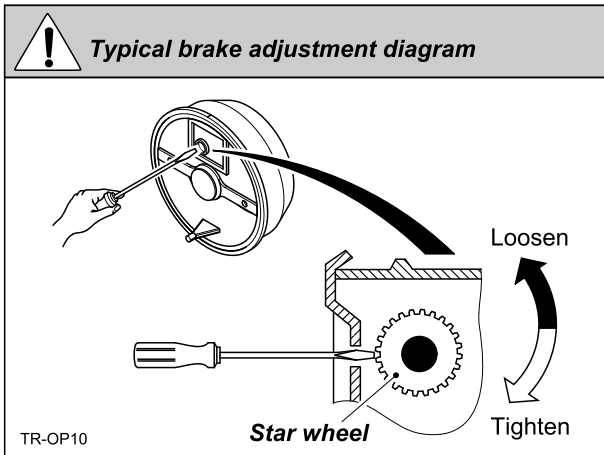

### • Brake lines adjustment

- 1) Apply the handle up to the first tooth, and check that there is equal braking resistance on each wheel. If not, proceed to the adjustment.
- 2) Lift the trailer using a suitable jack and make sure the jack stands are placed on secure level ground.
- 3) Before and during the adjustment of the wheel brakes always rotate the wheel in the forward direction.
- 4) Extend the bumper (if applied).
- 5) Release the brake handle completely.
- 6) Loose hexagonal nut and ball nut in the balance bar to release the brake linkage from the balance bar.
- 7) Measured (by applying the handle) lever on the inner cable where attached to the axle abutment bracket. The free play should be approx. 5 mm and as uniform as possible for 2 or 4 wheel brakes respectively.
- 8) Setup the free play of the brake as “**Drum brake adjustment**”.
- 9) Adjust the ball nut of the brake cable to adjust the balance bar perpendicularly to the brake rod.
- 10) Secure the ball nut with the hexagonal nut.
- 11) Apply strongly the handle lever up 3 times to allow the braking adjustment to settle.
- 12) Adjust the ball nut of the brake linkage to allow the handle lever to go to the 3rd or 4th tooth by

applying it (preliminary tension of 1 mm or 2 mm on the brake cable).

- 13) Secure the ball nut with the hexagonal nut.
- 14) Apply the handle lever up to the first or second tooth, and check that there is equal braking resistance on each wheel.

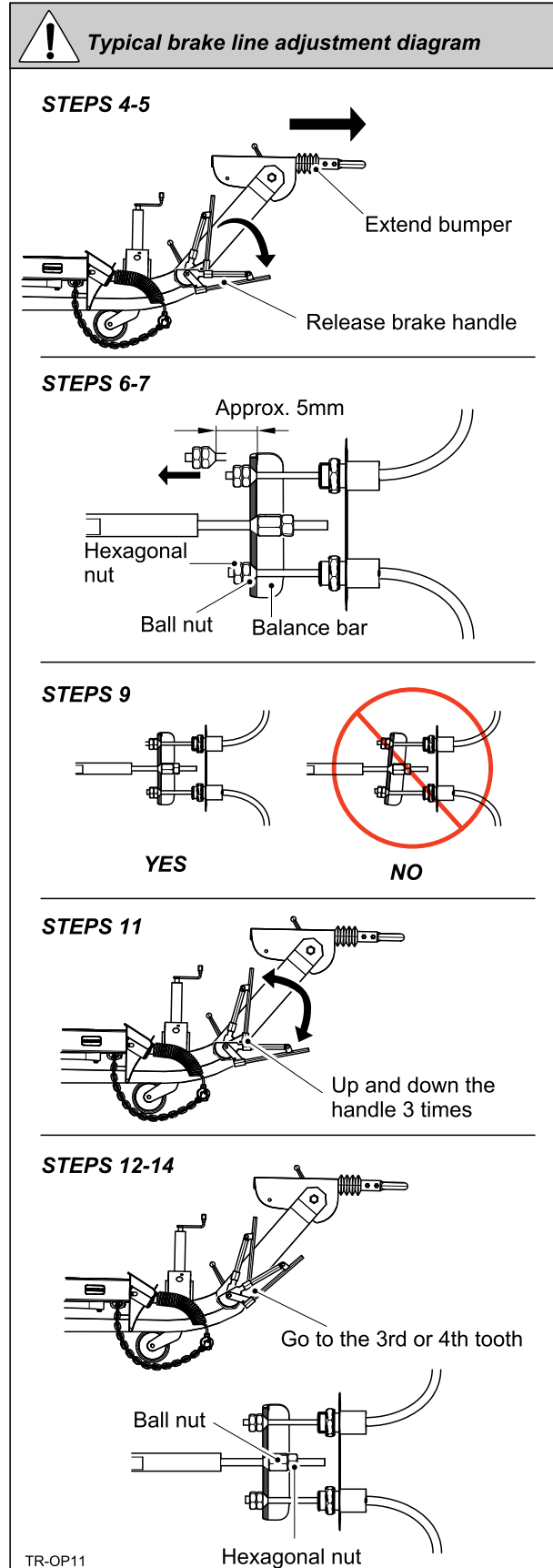

# 9 Troubleshooting

## 9.1 General

When performing any troubleshooting, follow the guideline below.

For detailed troubleshooting procedures about engine/alternator, refer to engine/alternator operation manual.

Keeping generator set level, making battery connections clean and tight, checking fuel level and not overloading etc., will help to reduce the possibility of engine shutdown.

Contact **POWERLINK** or our authorized distributor to ask for help for complicated maintaining and replacing operation.



GS-MT7

- Performing troubleshooting should be carried out by a licensed engineer.
- Before performing any troubleshooting stop engine and remove the start key, and always allow engine to cool because hot engine parts can cause severe burns.

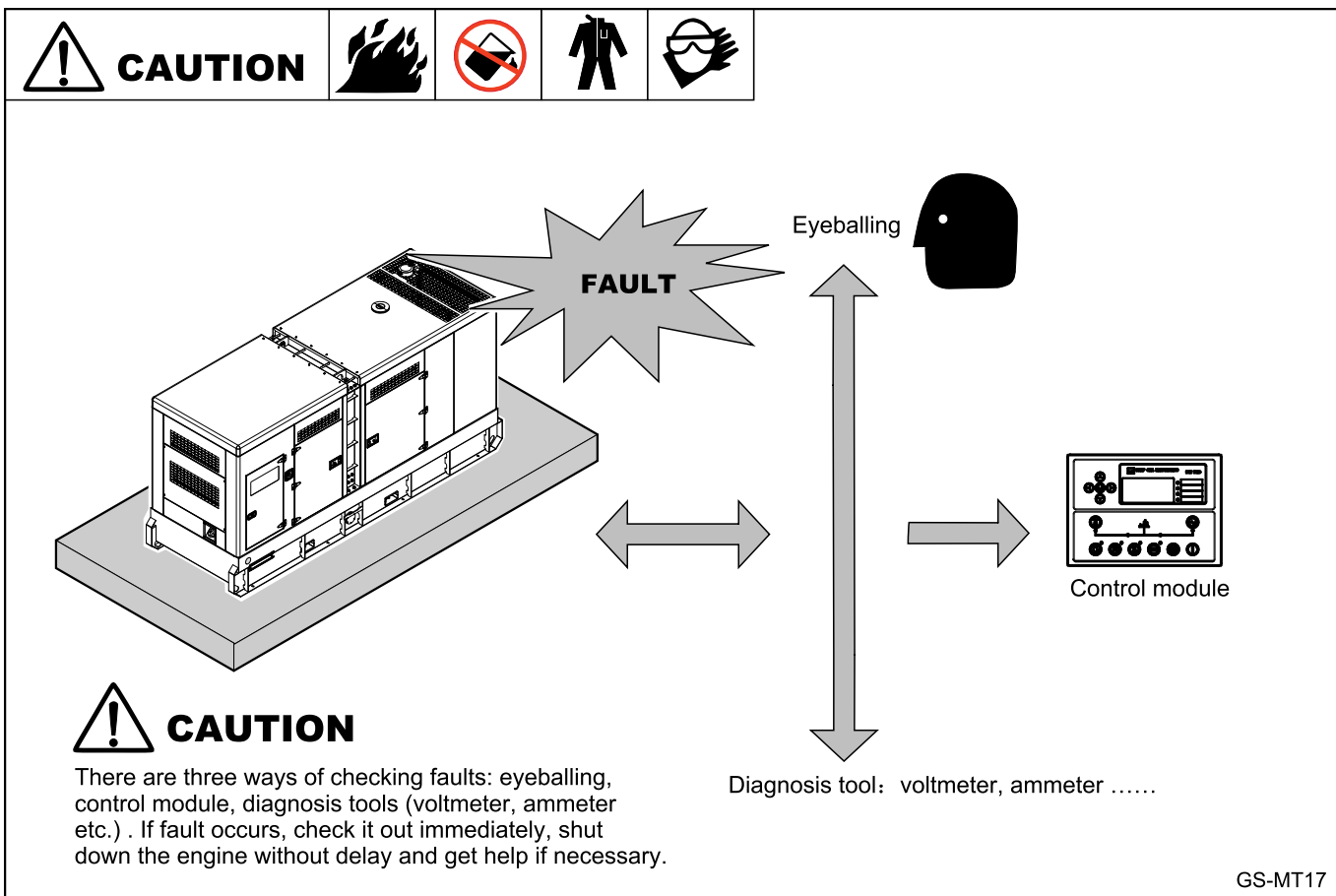

## CHAPTER 9 — TROUBLESHOOTING

### 9.2 Generator Set Troubleshooting

Trouble	Causes	Remedies
<b>Low engine oil pressure</b>	1. Oil pressure sensor is defective.	1. Repair or change the sensor.
	2. Lubricant oil is insufficient.	2. Add lubricant oil.
	3. Oil hose has leak.	3. Tighten or change oil hose.
	4. Oil filter is clogged.	4. Change oil filter.
	5. Improper kind of oil is used.	5. Change to proper kind of oil.
<b>High coolant temperature</b>	1. Coolant is insufficient .	1. Add coolant.
	2. Coolant pipe has leak.	2. Tighten or change coolant pipe.
	3. Fan belt is loose.	3. Tighten the belt.
	4. Radiator core is clogged.	4. Clean radiator core.
	5. Coolant temperature sensor is defective.	5. Repair or change the sensor.
	6. Engine thermostat is defective.	6. Repair or change the thermostat.
<b>Low fuel level</b>	1. Fuel is insufficient.	1. Add fuel.
	2. Fuel tank has leak.	2. Repair or change fuel tank.
	3. Fuel level sensor is defective.	3. Repair or change the sensor.
<b>Power drops after running a period of time</b>	1. Air filter element is clogged, and air is insufficient.	1. Clean or change air filter element.
	2. Fuel filter is clogged, and fuel is insufficient.	2. Drain water/sediment or Change fuel filter.
	3. Engine ignition time is incorrect.	3. Adjust the ignition time as required.
<b>Ground metal part is electriferous</b>	1. Ground connection is defective.	1. Check ground wiring.
	2. Insulating resistance is too low.	2. Measure insulating resistance.

9.3 Control System Troubleshooting

Trouble	Causes	Remedies
<b>Main breaker cannot be turned to on</b>	1. The main breaker position rests on the position between ON and OFF improperly.	1. First turn the breaker to off , and then turn it to on.
	2. Short circuit on the load.	2. Check and repair the load circuit or change it .
<b>Control module cannot run</b>	1. Control module cable is disconnected to the battery.	1. Connect the module cable to the battery.
	2. Battery power is insufficient.	2. Charge the battery with the utility power.
	3. The fuse is damaged.	3. Change the fuse.
	4. Control module is defective.	4. Repair or change the control module.
<b>Voltage drops quickly when connecting to the load</b>	1. Loads total exceeds the rated current.	1. Decrease the loads to meet the rated output.
	2. AVR. of alternator is defective.	2. Check AVR. and change it if necessary.
	3. Use wrong frequency.	3. Adjust the frequency to the load frequency.
<b>Frequency is stable, but voltage is unstable</b>	1. AVR. of alternator is defective.	1. Check AVR. and change it if necessary.
<b>After connecting to the load, voltage and frequency is stable, but current is unstable</b>	1. Customer load is unstable.	1. Check and adjust the customer load.
<b>Voltage cannot go up to the rated value</b>	1. AVR. of alternator is defective.	1. Check AVR. and change it if necessary.
	2. Frequency is low.	2. Adjust frequency as required
<b>Voltage exceeds the rated value</b>	1. AVR. of alternator is defective.	1. Check AVR. and change it if necessary.
<b>Electric meter has no reading</b>	1. The meter is defective.	1. Check the meter, and change if necessary.
	2. Circuit is disconnected, or terminal is loose.	2. Find the cut position and connect again.

**9.4 Engine Troubleshooting**

Trouble		Causes	Remedies
<b>Engine cannot start</b>	<b>Starter motor cannot drive or speed is low</b>	1. Battery switch is off.	1. Turn the switch to on.
		2. Battery output is weak.	2. Charge the battery.
		3. Battery is deteriorated.	3. Change the battery.
		4. Battery terminal is loose.	4. Tighten the terminal.
	<b>Starter motor drives, but engine cannot start</b>	1. Fuel is insufficient.	1. Check fuel system, and add fuel if necessary.
		2. Fuel hose has leak.	2. Tighten or change fuel hose.
		3. Fuel filter is clogged.	3. Drain water/sediment or Change fuel filter.
		4. Gauze filter is clogged.	4. Clean or change gauze filter.
		5. Air is mixed in fuel line.	5. Extract the air.
<b>Engine starts but stalls at once</b>	1. Fuel hose has leak.	1. Tighten or change fuel hose.	
	2. Fuel filter in the water/fuel separator is clogged.	2. Drain water/sediment or Change fuel filter.	
	3. Gauze filter is clogged.	3. Clean or change gauze filter.	
	4. Lubricant oil is insufficient.	4. Check oil level, add oil as required.	
	5. Air is mixed in fuel line.	5. Extract the air.	
	6. Air filter element is clogged.	6. Clean or change air filter element.	
<b>Output is insufficient</b>	1. Fuel is insufficient .	1. Check fuel system, and add fuel if necessary.	
	2. Overheating of moving parts.	2. Check to see if lubricating oil filter is working properly.	
	3. Air filter element is clogged.	3. Clean or change air filter element.	
	4. Injection pump is defective.	4. Check the fuel injection pump element and delivery valve assembly, replace if necessary.	
<b>Muffler releases black smoke</b>	1. Improper kind of fuel is used.	1. Select proper fuel.	
	2. Air filter element is clogged.	2. Clean or change air filter element.	
	3. Loads total exceeds the rated current.	3. Adjust the loads to meet the rated output.	
	4. Accumulation of gas carbon is high on the exhaust pipes and muffler.	4. Clean out gas carbon.	
<b>Muffler releases white smoke</b>	1. Air filter element is clogged.	1. Clean or change air filter element.	
	2. Lubricant oil is redundant and exceeds the limited.	2. Drain the redundant oil.	
	3. The piston ring(s) is(are) worn out.	3. Change piston ring(s).	
	4. Large clearance between cylinder and piston.	4. Change the piston and cylinder.	
<b>Muffler releases blue smoke</b>	1. Fuel contains water or air	1. Check and change the fuel, check and clean the fuel system.	
	2. Injector nozzle atomizes badly.	2. Repair or change Injector nozzle.	
	3. The cylinder or/and gasket is damaged.	3. Repair or change cylinder and gasket.	

Trouble	Causes	Remedies
<b>Engine overheats</b>	1. Lubricant oil is insufficient.	1. Check oil level, add oil as required.
	2. Fan belt broken or elongated.	2. Change belt or adjust belt tension.
	3. Coolant insufficient.	3. Add coolant.
	4. Radiator net or radiator fin clogged with dust.	4. Clean net or fin carefully.
	5. Improper kind of fuel is used.	5. Select proper fuel.
	6. Coolant temperature gauge or sensor is defective.	8. Check coolant temperature gauge or sensor and replace if necessary.
	7. Overload running.	7. Reduce load.
	8. Radiator core or coolant route is clogged.	8. Clean or replace radiator or defective parts.
	9. Fan, radiator cap or radiator is defective.	9. Replace radiator or defective parts.
	10. Thermostat is defective.	10. Check thermostat and replace if necessary.
<b>Engine shut off failure</b>	1. Electrical or manual fuel shutoff not closing.	1. Verify the solenoid is not being energized by a short in the wiring. Check the linkage to the shutoff lever for binding. Check for the ability of the spring in the solenoid to move the lever to the shutoff position.
	2. Fumes generated while the engine is running is drawn into air intake.	2. Locate and isolate the source of fumes.
<b>Engine surges at idle</b>	1. Air is mixed in fuel line.	1. Extract the air in fuel system and check for suction leaks.
	2. Idle speed is set too low.	2. Check and adjust low idle screw.
	3. Fuel filter is clogged.	3. Drain water/sediment or change fuel filter as necessary.

**9.5 Alternator Troubleshooting**

<b>Trouble</b>	<b>Causes</b>	<b>Remedies</b>
<b>No voltage or voltage is insufficient while running</b>	1. Winding is cut.	1. Intertwist the cut winding and weld firmly .
	2. Wiring terminal is loose.	2. Tighten the wiring terminal .
	3. Wiring terminal is defective.	3. Clean or replace the defective terminal .
	4. Speed is too low.	4. Adjust the speed and keep the rated speed.
<b>Voltage is unstable</b>	1. Speed is unstable.	1. Keep the rated speed.
	2. AVR is defective.	2. Check AVR, and change if necessary.
<b>Alternator overheats</b>	1. Overload running.	1. Reduce load.
	2. Vent-pipe inside the alternator is clogged.	2. Blow and clean the inner .
<b>Voltage is too high</b>	1. Speed is too high.	1. Keep the rated speed.
	2. AVR is defective.	2. Check AVR, and change if necessary.
<b>Voltage is too low while running without load</b>	1. Speed is too low.	1. Keep the rated speed.
	2. AVR is defective.	2. Check AVR, and change if necessary .
<b>Voltage is correct without load, but too low under load</b>	1. Speed setting is incorrect.	1. Check and adjust the speed.
	2. Short circuit on the rotor.	2. Check resistance of the circuit.
	3. Armature of excitation is defective.	3. Check resistance of the circuit.
<b>Voltage disappears while running</b>	1. Winding of magnetic field is cut.	1. Check the cut winding, intertwist and weld firmly .
	2. Rotor of excitation is defective.	2. Check rotor, repair it and change if necessary.
	3. AVR is defective.	3. Check AVR, and change if necessary.

## 9.6 Battery Charge Troubleshooting

Trouble	Causes	Remedies
<b>No charge current</b>	1. Battery post is defective.	1. Check and clean the post.
	2. Battery post is connected incorrectly.	2. Check the connection post.
	3. No mains supply.	3. Check the wiring to the charger from mains supply.
	4. Power fuse is burned-out .	4. Change the fuse.
<b>Display nothing on the charge current meter</b>	1. Charge current meter is defective.	1. Measure the current with the standard amperemeter .
<b>Charge rate is too low</b>	1. Mains supply power is low.	1. Check mains supply.
	2. Plug of the charger transformer does not match with the mains supply voltage.	2. Check the plug of charger transformer.
	3. Battery post is loose.	3. Tighten the battery post.
<b>Fuse of mains supply is burned-out repeatedly</b>	1. Power of the fuse does not match.	1. Change the proper fuse.
	2. There is short circuit.	2. Check and connect all wiring.
<b>Charge clip heats</b>	1. Battery post is defective.	1. Check and clean the post.
	2. Bolt of the clip is loose.	2. Clean and tighten the bolt.
<b>Battery voltage does not rise</b>	1. Battery is deteriorated.	1. Change the battery.
	2. Battery has been damaged.	2. Check the battery, and change it if necessary.

C
01.28.2016

<http://www.powerlinkworld.com>

*Specification may change without prior notice. For more info.,  
contact Power Link or your local distributors please.*